

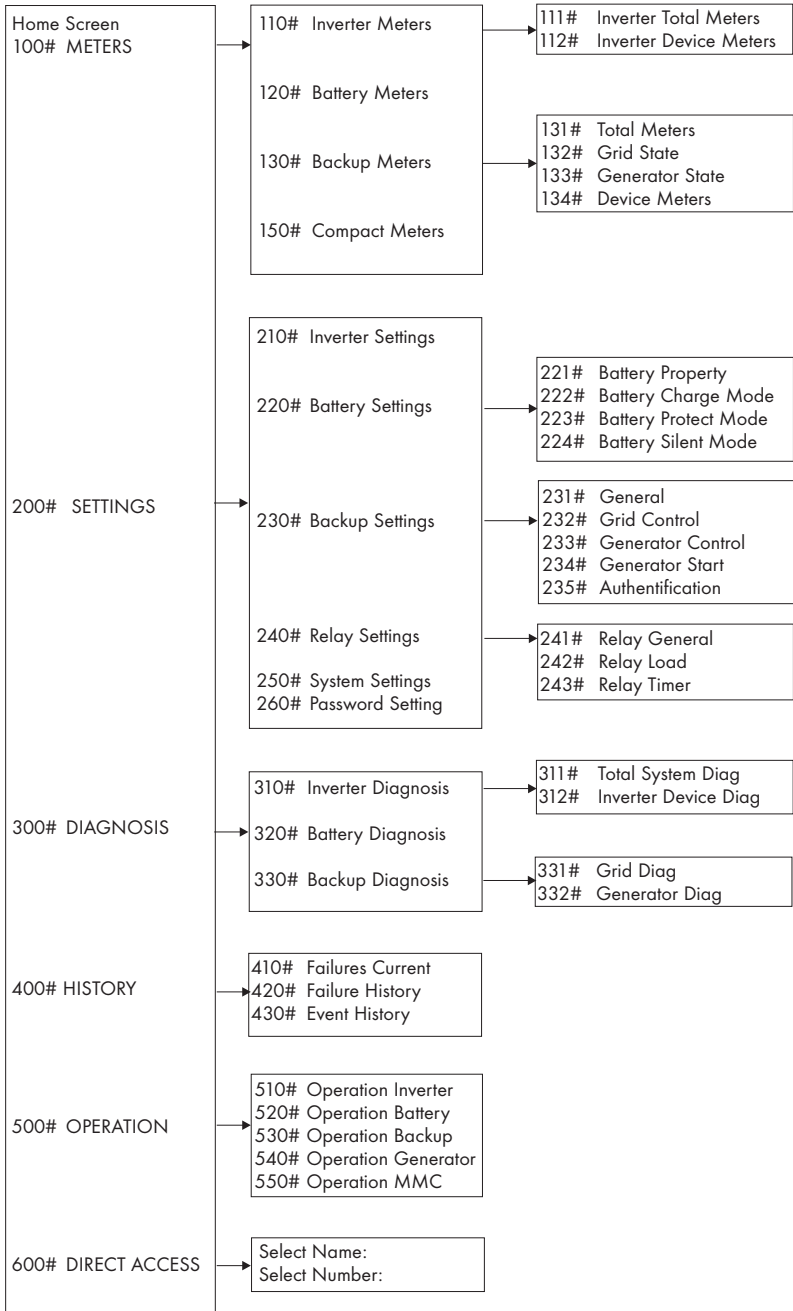

# Sunny Backup 5000 Installation & Instruction Manual





# Table of Contents

<b>1</b>	<b>Notes on this Manual.</b> . . . . .	<b>9</b>
1.1	Validity . . . . .	9
1.2	Symbols Used . . . . .	9
1.3	Syntax. . . . .	10
<b>2</b>	<b>The Sunny Backup 5000</b> . . . . .	<b>11</b>
2.1	Properties . . . . .	11
2.2	At a Glance. . . . .	18
2.3	Dimensions . . . . .	19
2.4	Scope of Delivery Sunny Backup 5000 . . . . .	20
2.5	Required Tools and Resources . . . . .	21
2.6	Accessories (Optional) . . . . .	22
2.7	SMA Products (Optional) . . . . .	22
2.8	Name Plate/Firmware Version . . . . .	23
<b>3</b>	<b>Safety Instructions</b> . . . . .	<b>25</b>
3.1	Important Notes Regarding Operation . . . . .	25
3.2	Potential Hazards. . . . .	26
<b>4</b>	<b>Installation</b> . . . . .	<b>29</b>
4.1	Lifting/Moving . . . . .	29
4.2	Unpacking. . . . .	29
4.3	Minimum Clearance . . . . .	30
4.4	Wall Mounting. . . . .	31
4.5	Installing Batteries. . . . .	35
<b>5</b>	<b>Opening and Closing.</b> . . . . .	<b>37</b>
5.1	Opening and Closing of the Sunny Backup 5000 . . . . .	37
5.2	Opening and Closing of the Automatic Switch Box . . . . .	38

<b>6</b>	<b>Electrical Connection</b>	<b>39</b>
6.1	Grounding	40
6.2	DC Connection	42
6.2.1	Safety Precautions/Conditions	42
6.2.2	Cable Protection	43
6.2.3	Connection	43
6.2.4	Battery Connection Box (SBU-CON.33)	44
6.3	AC Connection	46
6.4	Additional Connections	47
6.4.1	Battery Temperature Sensor	47
6.4.2	Battery Current Sensor	49
6.4.3	Communication for Multi-device Connection	51
6.4.4	Multi-function Relay 1 and 2	53
6.4.5	BatVtgOut Power Supply	56
6.4.6	Digital Input, DigIn	57
6.5	Interface for External Communication	58
6.5.1	Connection of the Interface	59
6.5.2	Data Transmission Speed	61
6.6	GenMan Connection	62
6.7	Automatic Switch Box Connection	63
6.7.1	Feeding in the Energy Cables	63
6.7.2	Feeding in the Control and Measurement Cables	64
6.7.3	Supply Line (X1/Load Meter)	67
6.7.4	Sunny Backup 5000 (X2/Sunny Backup)	68
6.7.5	Consumer System (X3/Backup Loads)	68
6.7.6	PV System (X4/PV System)	69
6.7.7	PV Feed-in Counter (X5/PV Meter)	71
6.7.8	Generator (X6/Generator)	71
6.7.9	Signal-controlled feeding (X7/Feed In Signal)	72
6.7.10	ComSync Communication Cable	72
6.7.11	BackupVtgCur External Control Lines and Measurement Cables	72
6.7.12	Concluding Tasks	73

<b>7</b>	<b>Control Elements</b> . . . . .	<b>74</b>
7.1	Display Messages . . . . .	74
7.2	DC Circuit Breaker . . . . .	74
7.3	Buttons . . . . .	75
7.4	Meaning of the Light-emitting Diodes (LEDs) . . . . .	75
7.5	MMC/SD Card . . . . .	75
<b>8</b>	<b>(First) Commissioning</b> . . . . .	<b>77</b>
8.1	Requirements . . . . .	77
8.2	Starting the Quick Configuration Guide (QCG) . . . . .	77
<b>9</b>	<b>Activation and Deactivation</b> . . . . .	<b>81</b>
9.1	Activation / Startup . . . . .	81
9.2	Stopping . . . . .	82
9.3	Deactivation. . . . .	83
9.4	Disconnecting the Device from Voltage Sources. . . . .	83
9.5	Reactivating the Device Following Automatic Shutdown . . . . .	84
<b>10</b>	<b>Operation</b> . . . . .	<b>85</b>
10.1	Menu Structure. . . . .	87
10.2	Changing Parameters . . . . .	90
10.3	Direct Access . . . . .	91
10.4	Compact Meters. . . . .	91
10.5	Entering the Installer Password . . . . .	94
10.6	Display Messages (Overview) . . . . .	96
10.7	Entering the Installer Identification . . . . .	98
10.8	Parameter Display . . . . .	99
10.9	Display of Events . . . . .	99
10.10	Display of Warnings and Errors . . . . .	100

<b>11</b>	<b>Archiving Data on an MMC/SD Card. . . . .</b>	<b>101</b>
11.1	Inserting the Card. . . . .	103
11.2	Removing the Card. . . . .	104
11.3	Saving and Loading Parameters. . . . .	104
11.4	Writing Log Data . . . . .	105
11.5	Status Messages. . . . .	105
11.6	Firmware Update . . . . .	106
<b>12</b>	<b>Inverter Operation. . . . .</b>	<b>108</b>
12.1	Overload and Short-circuit Behavior. . . . .	108
12.2	Device Faults and Autostart . . . . .	108
<b>13</b>	<b>Grid . . . . .</b>	<b>109</b>
13.1	Conditions . . . . .	109
13.2	Operating on the Public Grid. . . . .	110
13.3	Grid Failure . . . . .	110
13.4	Stand-Alone Grid Operation . . . . .	110
13.5	Grid Reconnection . . . . .	110
13.6	Limits and Power Adjustment . . . . .	111
13.7	Grid feeding from the battery. . . . .	112
13.7.1	Time-dependent grid feeding. . . . .	113
13.7.2	Signal-controlled grid feeding . . . . .	113
<b>14</b>	<b>Battery Management. . . . .</b>	<b>115</b>
14.1	Battery Temperature . . . . .	115
14.2	Start Options . . . . .	116
14.3	State of Charge/SOC and SOH . . . . .	116
14.4	Charge Control . . . . .	117
14.4.1	Boost Charge . . . . .	119
14.4.2	Full Charge . . . . .	119
14.4.3	Equalization Charge. . . . .	120

14.4.4	Silent Mode . . . . .	120
14.4.5	Manual Equalization Charge . . . . .	120
14.5	Battery Preservation Mode . . . . .	121
14.6	Battery Diagnostics . . . . .	122
<b>15</b>	<b>Connecting a Generator . . . . .</b>	<b>123</b>
15.1	Generator Start . . . . .	123
15.2	Generator Operation . . . . .	125
15.2.1	Manual Generator Operation . . . . .	125
15.2.2	Automatic Generator Operation . . . . .	126
15.3	Limits and Power Adjustment . . . . .	128
15.4	Run Times . . . . .	129
15.5	Operation Together With Sunny Boys. . . . .	130
15.6	Stopping the Generator . . . . .	130
15.7	Stopping the Sunny Backup 5000 . . . . .	131
15.8	Failures . . . . .	131
<b>16</b>	<b>Relay . . . . .</b>	<b>133</b>
<b>17</b>	<b>Sunny Boy . . . . .</b>	<b>135</b>
17.1	Setting the Stand-alone Grid Parameters . . . . .	135
17.2	Frequency Shift Power Control (FSPC) . . . . .	137
<b>18</b>	<b>Maintenance and Care . . . . .</b>	<b>139</b>
18.1	Housing. . . . .	139
18.2	Cleaning the Fans. . . . .	139
18.3	Display . . . . .	139
18.4	Functioning . . . . .	139
18.5	Battery . . . . .	140
18.6	Disposal . . . . .	140
18.7	Sunny Backup System Test. . . . .	140

<b>19</b>	<b>Parameter Lists</b> . . . . .	<b>141</b>
19.1	Display Values . . . . .	142
19.2	Adjustable System Parameters . . . . .	145
19.3	Diagnostics . . . . .	154
19.4	Events, Warnings and Errors (History). . . . .	156
19.5	Functions in Operation . . . . .	156
<b>20</b>	<b>Troubleshooting/Problem Solving</b> . . . . .	<b>159</b>
20.1	Error Confirmation . . . . .	159
20.2	Autostart Handling . . . . .	159
20.3	Master Slave Handling . . . . .	159
20.4	Handling Pending Errors During the Booting Procedure . . . . .	160
20.5	Display of Errors and Events . . . . .	160
20.6	Events . . . . .	161
20.7	Error Categories . . . . .	163
20.8	Warnings and Error Messages. . . . .	163
20.9	Troubleshooting . . . . .	168
<b>21</b>	<b>Technical Data</b> . . . . .	<b>175</b>
21.1	Sunny Backup 5000 . . . . .	175
21.2	Automatic Switch Box . . . . .	178
21.3	Battery Connection Box (SBU-CON.33) . . . . .	180
<b>22</b>	<b>Certificates</b> . . . . .	<b>181</b>
<b>23</b>	<b>Contact</b> . . . . .	<b>183</b>
<b>24</b>	<b>Glossary</b> . . . . .	<b>184</b>



# 1 Notes on this Manual

This technical description is intended for both the installer as well as the end customer. It is intended to assist in correctly mounting, installing and operating as well as understanding the operating principles of a Sunny Backup system.

Information regarding the following subjects can be found in the specified sections:

- Installation starting in section 2 "The Sunny Backup 5000" (Page 11)
- Commissioning starting in section 7 "Control Elements" (Page 74)
- Functionality starting in section 12 "Inverter Operation" (Page 108)
- Appendix starting in section 18 "Maintenance and Care" (Page 139)

## 1.1 Validity

This technical description applies to firmware version 3.004 and above, and to hardware version T and above (2.8 "Name Plate/Firmware Version" (Page 23)).

You can read the firmware version of your device on the display using the "312.02 FwVer" parameter (see section 19.3 "Diagnostics" (Page 154)).

This product may only be operated within the intended area of application described in this documentation.

Do not use the Sunny Backup 5000 for purposes other than those indicated in this technical description. Use of the device for other purposes can void the warranty as well as damage both the device and the system.

If you require further information, please contact the Sunny Island Hotline at +49 561 95 22 399 or by e-mail: [SunnyIsland.Service@SMA.de](mailto:SunnyIsland.Service@SMA.de).

## 1.2 Symbols Used

To ensure optimum use of this manual, note the following explanations of symbols used.

**This symbol indicates a danger.**

**If these instructions are ignored, a significant danger of injury or death arises and damage to the device, system or plant may also result.**



This symbol indicates a notice.

Failure to observe this notice can make a working step more difficult, and may hinder optimum operation of the device.



This symbol indicates an example.

Here you will find supplementary examples on concrete topics.



## 1.3 Syntax

The syntax specified here for menus and parameters apply to the entire document:

**Menu:** menu number, hash and menu name (150# Grid Meters)

**Parameter:** menu number, dot, parameter number and parameter name  
(150.01 GdRmgTm)

## 2 The Sunny Backup 5000

### 2.1 Properties

The Sunny Backup system comprises one or more Sunny Backup 5000s in combination with an Automatic Switch Box (AS-Box-M, AS-Box-L or AS-Box-XL). This system is specially designed for backup applications and enables, in compliance with all standard requirements, continued operation of a grid-connected PV system in the event of grid failure. Thus, this system does not replace the conventional PV inverter (Sunny Boy), but is installed additionally. In the event of grid failure, the Sunny Backup system first ensures safe disconnection of the loads and the PV system from the public grid, and subsequently forms a stable stand-alone grid, into which the Sunny Boy can then feed solar energy. The maximum period of interruption for the loads is approximately 20 ms, which for most loads is equivalent to uninterrupted operation.

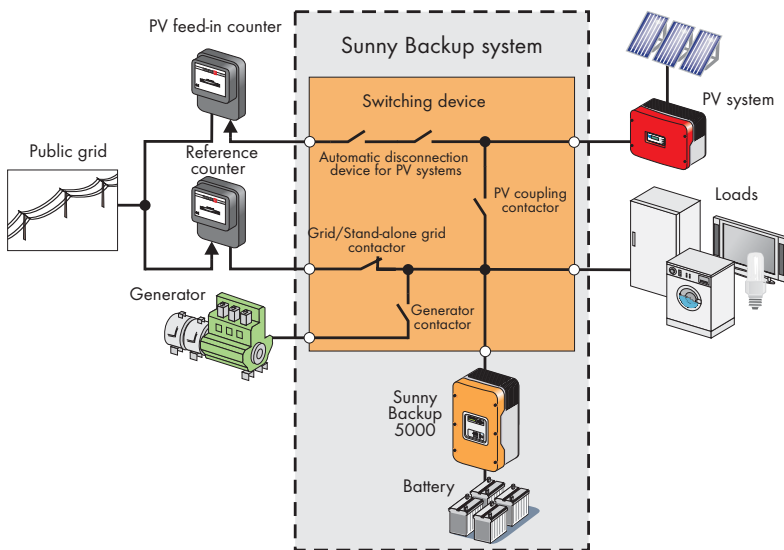

The Sunny Backup system is suitable for use in conjunction with all Sunny Boys and Sunny Mini Centrals from **SMA** Technologie AG. The modular structure allows the suitable construction of systems with a maximum consumer power of approximately 5 kW to 100 kW. The Sunny Backup system can be integrated into new PV system installations, and can also be retrofitted onto existing PV systems.

Along with the Sunny Backup 5000 inverter and the automatic switching device, a battery is necessary as a short-term storage device, for reliable operation. During grid failure, the battery has the task of correcting the imbalance between generation and consumption. Whenever less energy is being generated than consumed (e.g. at night),

the battery is discharged. Whenever more energy is being generated than consumed (e.g. during the day), the battery is charged. The intelligent battery management built into the Sunny Backup 5000 protects the battery from overcharging and deep discharge. This ensures that the battery service life stipulated by the battery manufacturer can be achieved.

All regulation and control is performed by the Sunny Backup 5000. If the system is in grid-parallel operation, the Sunny Backup 5000 ensures standard-compliant grid monitoring and battery-preserving charging. The Sunny Backup 5000 is extremely quick to detect any failure of the public grid, and sends the command to the switching device to disconnect the system from the grid. After a maximum of 20 ms, the loads will be already supplied with electricity again, from the battery. After a matter of seconds, the PV system switches to this stand-alone grid, and either powers the loads, or is used for recharging the batteries. The efficiency during charging, regardless of whether from the grid, or from the PV system, and during discharging, is up to 95 %. Due to the Sunny Backup 5000's very high overload capability of up to 8.4 kW for 60 seconds, and its integrated smooth startup, critical loads with very high start currents can also be started safely. Thus, over-dimensioning of the inverter is not necessary.



The Sunny Backup system meets all requirements of the VDE 0126-1-1 directive, which is necessary in Germany. The switching devices for PV feeding are implemented redundantly, and are monitored. The safety of this system has been inspected and certified by the German Professional Association for Precision Engineering and Electrotechnology.



The Sunny Backup system is only intended for use in TN grids!

The automatic switching device is also available with an optional additional connection for an emergency power generator. Thus, the system's reliability of supply can be increased further, and a smaller battery can be used. In this case, the Sunny Backup 5000 also conducts the startup and synchronization of the emergency power generator, and connects it to the consumer grid with the switching device. The generator now powers the loads, and charges the batteries. Once the batteries are charged sufficiently, the Sunny Backup 5000 automatically stops the generator.

Despite the complex functions of the Sunny Backup system, it can be installed and configured with ease. All special material required for installation is included in the delivery. Additional sub-distribution units are generally not necessary. The safety and fuse protection concept on the consumer side, and that of the PV system, are generally not impaired by the Sunny Backup 5000, and do not need to be adapted.

All the settings required for operation can be quickly and easily programmed in six steps using the "Quick Configuration Guide". By employing the concept of central operation referred to as "Single Point of Operation", the parameters of a multi-phase

system are only set on the master device, and all other devices automatically adopt the configuration. The easy-to-understand menu navigation allows quick access to all important data, even while the system is running. An MMC/SD card provides uncomplicated system control, and thus makes any service work easier.

Always use the MMC/SD card to save data and events. This is necessary in order for **SMA** Technologie AG to be able to help you in the event of a fault.



The Sunny Backup System can also be used to realise a decentralised grid stabilisation. This battery grid feed feature enables the user to feed power from the batteries into the electrical grid when required. The feeding from the battery can be time-dependent or initiated via an external dry contact, for example a ripple control signal which is sent from the energy supplier.

Before using the battery grid feed feature, please contact your energy supplier in order to verify the local standards.



The graphics on the next pages show the different wiring options (1-phase and 3-phase).

### Single-phase Sunny Backup system

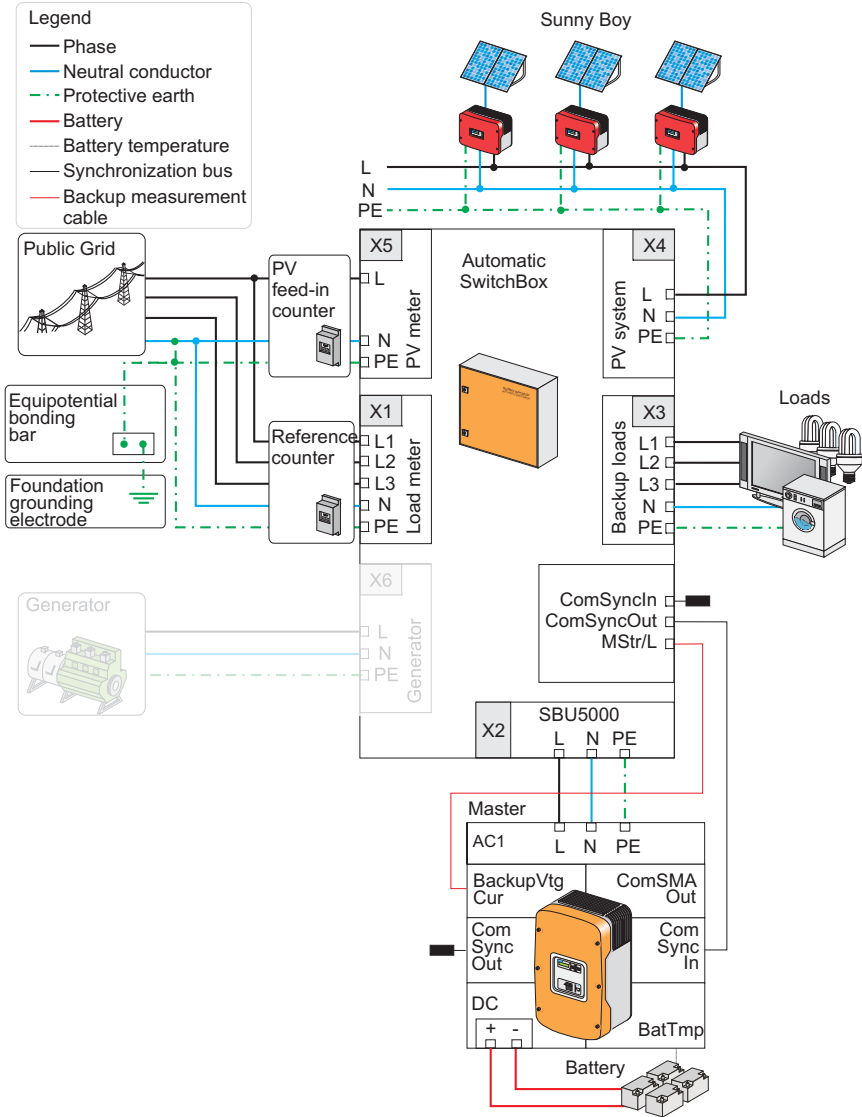

### Single-phase Sunny Backup system

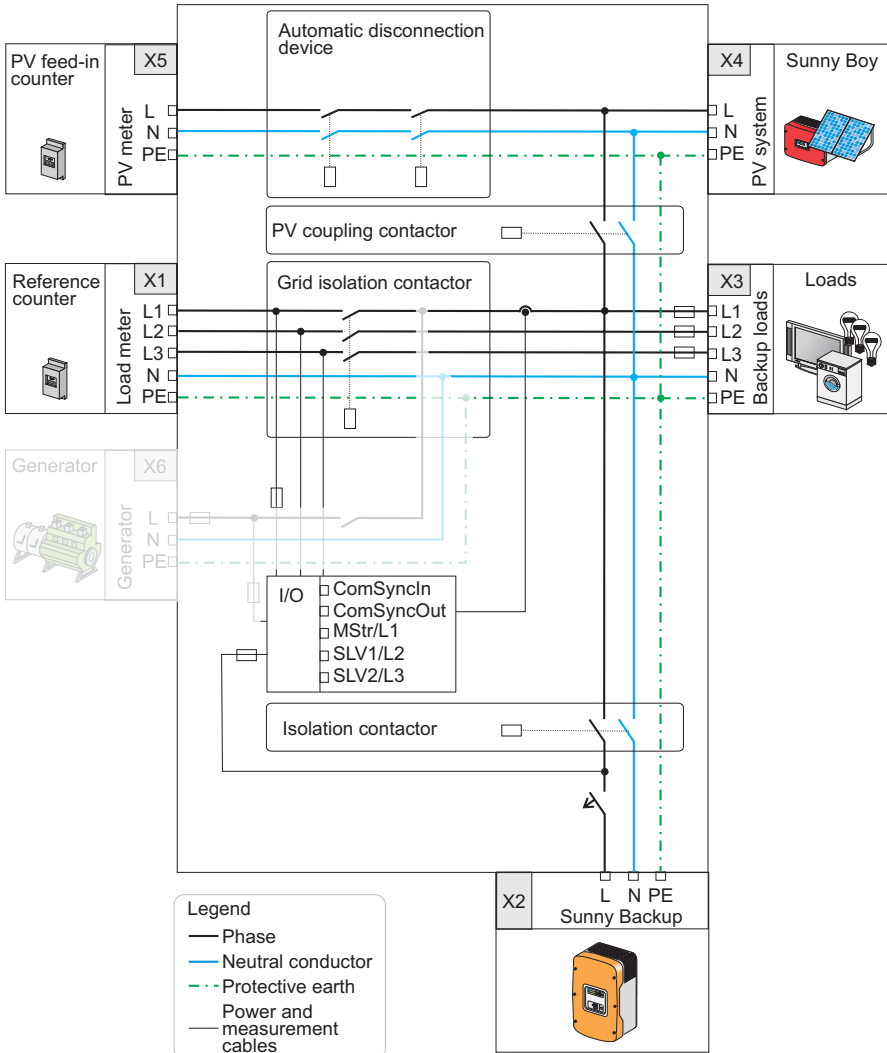

### Three-phase Sunny Backup system

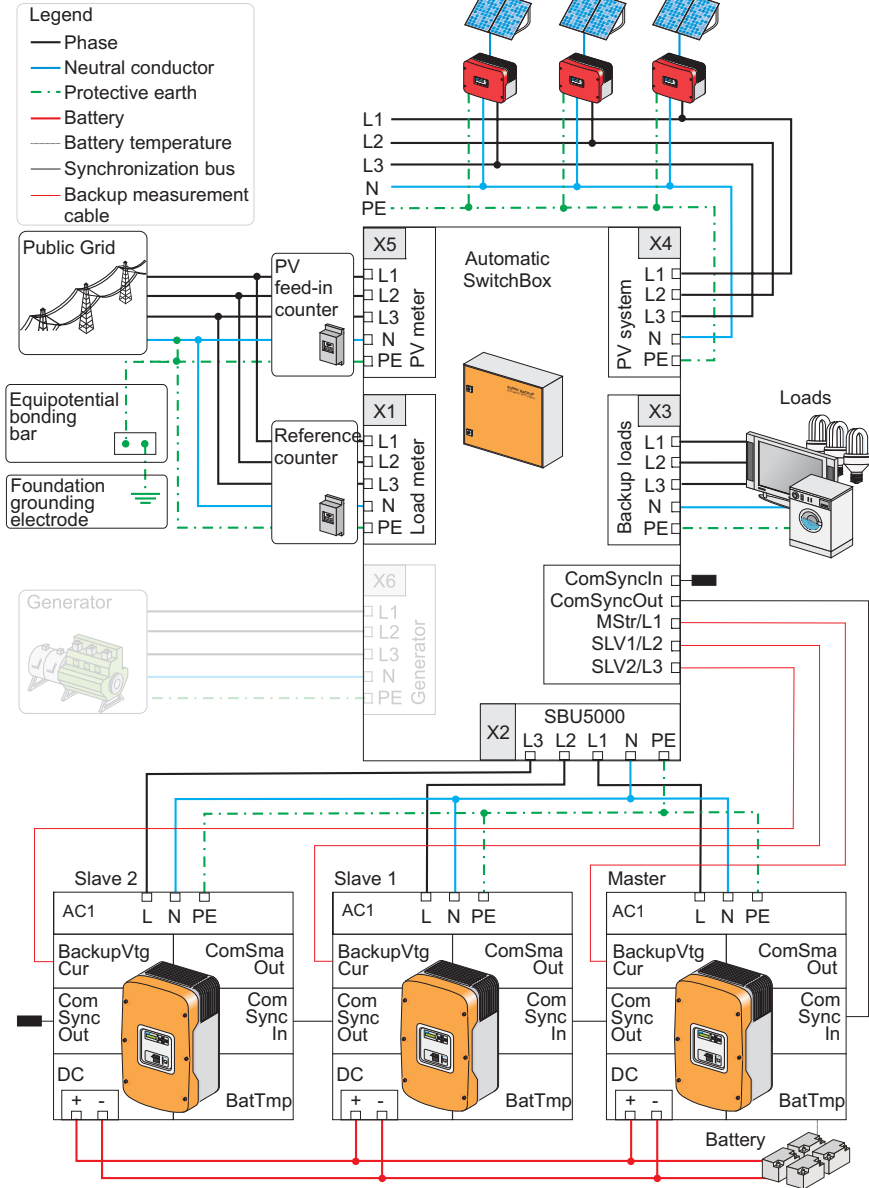



### Three-phase Sunny Backup system

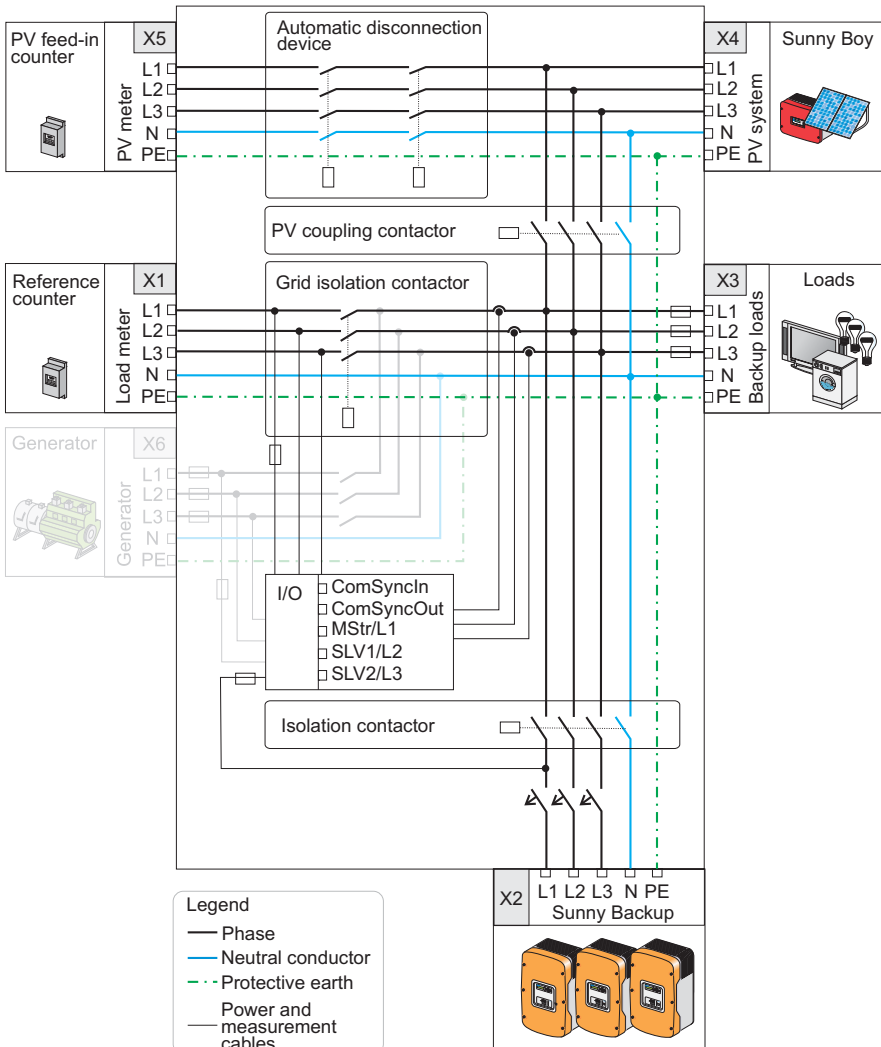

## 2.2 At a Glance

The following figure provides an overview of all control elements and connections of the Sunny Backup 5000:

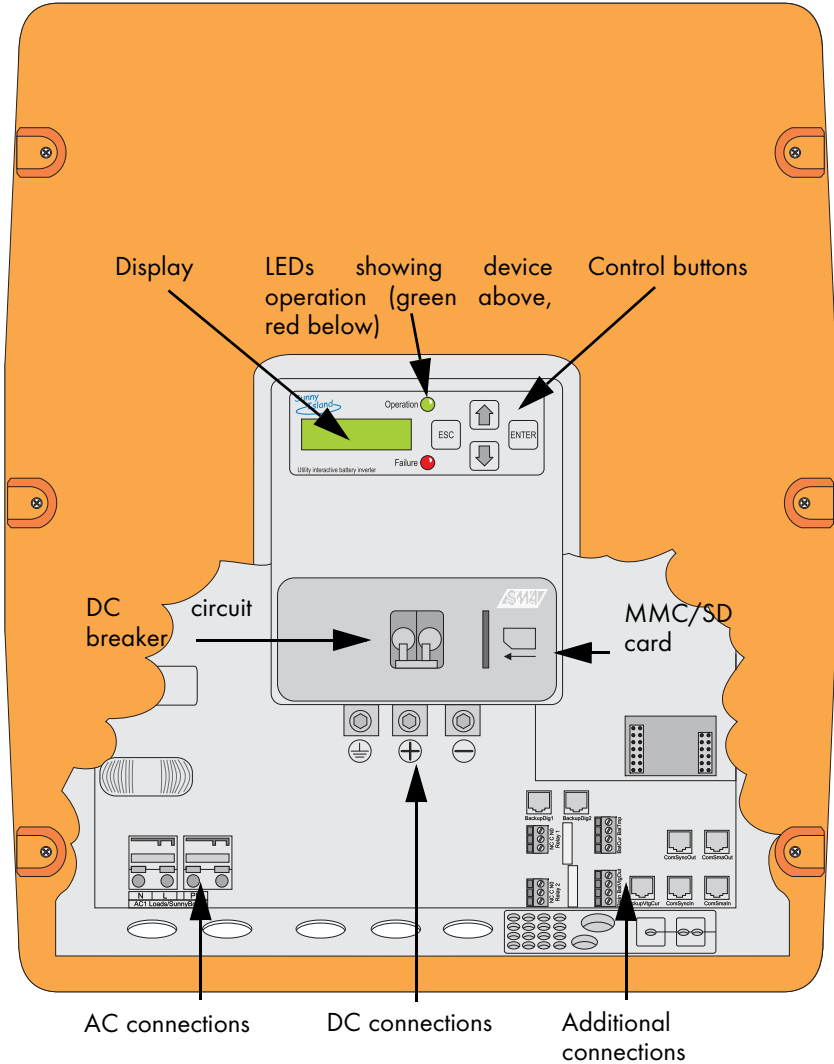

## 2.3 Dimensions

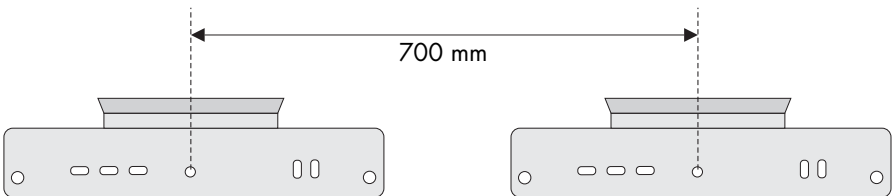
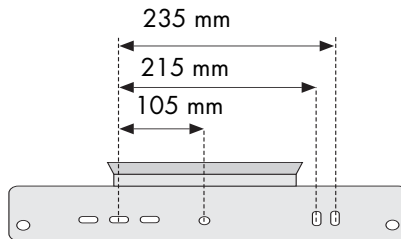
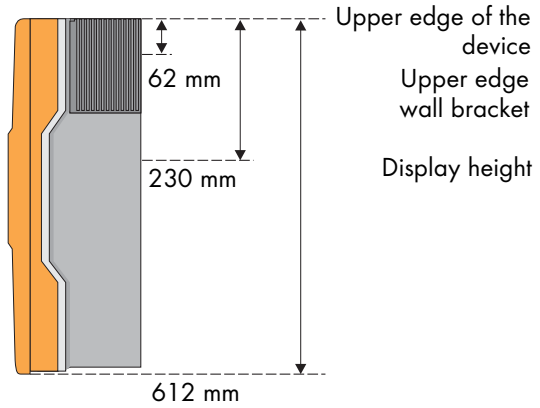
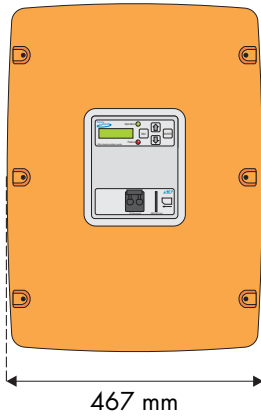
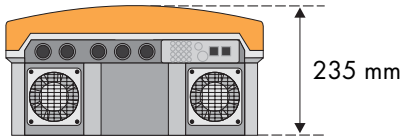

## 2.4 Scope of Delivery Sunny Backup 5000

The following elements are included:

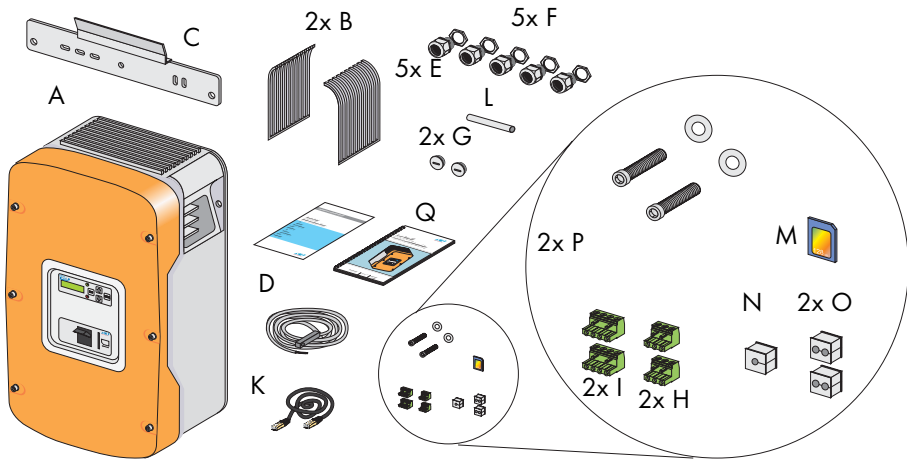

A	1	Sunny Backup 5000 with housing cover
B	2	air grills
C	1	wall bracket
D	1	battery temperature sensor
E	5	M25 metric-thread cable screw connections
F	5	M25 nuts (adapter M32->M25)
G	2	metric-thread dummy plugs
H	2	3-pole print terminals (for connecting relays 1 & 2)
I	2	4-pole print terminals (for connecting battery temperature/electricity sensor)
K	1	RJ45 communication cable (black, 2 m) for internal communication (between several Sunny Backup 5000)
L	1	silicone tube 10 mm x 0.5 m
M	1	128 MB SD card
N	1	rubber plug for feed-through of one cable
O	2	rubber plugs for feed-through of two cables
P	2	M6 x 10 mm hexagon socket screws incl. M6 contact disks for connecting the Sunny Backup 5000 to the wall bracket

Q 1 installation and user manual

The scope of delivery of the Automatic Switch Box, and that of the battery, can be found in these products' respective documentation.



## 2.5 Required Tools and Resources

The following tools are recommended for mounting and installing the Sunny Backup 5000:

### Tools (not included in delivery)

Stripping pliers

Cable end sleeves

Drill

Drill (e.g. stone drill), Ø 10 mm

Torque wrench (4 Nm to 5.7 Nm) with flathead screwdriver adapters in the sizes 10/5.5/2.5 mm

Hexagon (allen) key, 3 mm to 8 mm

Cable knife

Combination pliers

Phillips screwdriver, PH1 and PH2

Cable

Open-end/ring wrenches or socket wrench in the sizes 10/19/24/30

Multimeter

Crimping tool for cable lugs (suitable for cable cross-sections of up to 70 mm<sup>2</sup>)

Flathead screwdriver, 0.4 x 2.5 mm/1.0 x 10 mm/1.0 x 5.5 mm

Diagonal cutting pliers

Spirit level

Ratchet

Ratchet extension

### Material (not included in delivery)

Wall anchors for the wall bracket (e.g. SX 10)

Cable ties

## Material (not included in delivery)

- Ring cable lugs (with hole size for M8 screws)
- Heat shrink tubing
- Hexagon bolts, 8 × 60 mm, washers

## 2.6 Accessories (Optional)

The following accessories for the Sunny Backup 5000 are also available:

- Separate fuse for the battery (SMA order number: "SI-BATFUSE-...")  
Enables cable protection (used with strip fuse ...-SIBA-...) or disconnection with cable protection (used with NH fuse ...-NH01-...) of the Sunny Backup 5000 from the connected battery.
- Separate connection box for the battery (SMA order number: "SBU-Con.33-...")  
Enables connection of several batteries to several Sunny Backup 5000s (see section 6.2.4 "Battery Connection Box (SBU-CON.33)" (Page 44)).
- Separate multicuster Piggy-Back (SMA order number: "MC-PB-...")

**Required in multicuster systems for communication between the main master and the sub-masters.**

**SMA** Technologie AG also offers an extensive range of products allowing you to communicate with the Sunny Backup 5000 to query data, and much more. Among these devices are:

- Sunny WebBox
- Sunny Sensor Box

The software for configuration of your inverter, and for reading and analyzing the data, can be found at the **SMA** Technologie AG website, at [www.SMA.de](http://www.SMA.de), and can be downloaded for free (see section 23 "Contact" (Page 183)).











## 2.7 SMA Products (Optional)

The Sunny Backup 5000 can be used in conjunction with all PV inverters from **SMA** Technologie AG.

## 2.8 Name Plate/Firmware Version

You can identify the Sunny Backup 5000 from the name plate and firmware version.

- The name plate is located on the left side of the housing.
- You can read the firmware version of your device on the display using the "312.02 FwVer" parameter (see section 19.3 "Diagnostics" (Page 154)).

SMA Technologie AG www.SMA.de		
<b>SUNNY BACKUP</b> Utility Interactive Battery Inverter • Made in Germany		
Type	Serial No.	
<b>SBU 5000</b>	<b>1260001147T</b>	
Art. No.		
<b>SB5010-DE0-601000</b>		
  	V <sub>DC nom</sub>	48 V
	I <sub>DC nom</sub>	100 A
	V <sub>AC nom</sub>	230 V
	f <sub>AC nom</sub>	50 Hz
	P <sub>AC nom</sub>	5000 W
	I <sub>AC nom</sub>	21,7 A
IP 30 indoor		
		
 *2000165882*		
		





## 3 Safety Instructions

### 3.1 Important Notes Regarding Operation

Please follow all operating and safety instructions in this manual. If these instructions are ignored, a significant danger of injury or death arises and damage to the device, system or plant may also result. Carefully read through the safety instructions **before** installing and commissioning the device. Store the manual at an easily accessible location.

**Be sure to observe all applicable regional standards and guidelines.**



**The Sunny Backup 5000 may only be installed or opened by qualified personnel (qualified electrician).**



**Never attempt to repair the device yourself. Unprofessional repair work can be dangerous. Please consult your dealer or SMA Technologie AG if a fault occurs.**



**The operating consumption of the Sunny Backup 5000 discharges the battery. In standby mode this load is about 4 W and in idle mode it is about 25 W. Observe this when you wish to install the Sunny Backup 5000, but do not wish to immediately use it.**



**It may be necessary to set the Sunny Backup 5000 to Stop mode (see section 9.3 "Deactivation" (Page 83) and disconnect it from the battery by means of the DC circuit breaker.**

## 3.2 Potential Hazards

Like any other power converter, the Sunny Backup 5000 is an electrical device that presents certain hazards when operated.



**Life-threatening voltages and currents occur within the Sunny Backup 5000. Complete protection against accidental contact is only provided when the following points are followed according to the handbook:**

- The device is mounted correctly.
- The device is properly grounded.
- All connections to the device are made correctly.
- The housing cover is securely closed.

If this is ignored, a significant danger of injury and death arises and damage to the device may also result.



**Before performing any maintenance work or installation work on the Sunny Backup 5000, you must make absolutely sure that all devices built in or connected to the system are completely isolated from all voltage sources (battery, (stand-alone) grid, generator). Ensure that the system cannot be accidentally switched on again. Proceed in the order given below:**

- Switch off all loads.
- Press and hold <ENTER> until the "Hold key to stop" message appears.
- Press and hold ENTER until the Sunny Backup 5000 stops and "STANDBY-To start press <ENTER>" appears on the display.
- Switch off the Sunny Backup 5000 using the DC circuit breaker and also disconnect the device from the batteries (e.g. using the optional SI-BattCase load disconnecting switch).
- Subsequently, disconnect the Sunny Backup 5000 from the AS-Box's AC connection (line circuit breaker in the AS-Box).
- Make sure that the Sunny Backup 5000 has been disconnected from all voltage sources.
- Wait at least five minutes to let the capacitors discharge and allow the voltage inside the device to drop to a safe level. In order to fully discharge, the capacitors require approximately 30 minutes. Make sure to avoid causing a short circuit on the DC side.
- Open the housing cover to ensure the device is not under voltage.

The Sunny Backup 5000 can start on its own. When working on the stand-alone grid, ensure that **ALL** sources of AC and DC power in the system have been switched off (see above).



When touching the device, please note that some parts of the Sunny Backup 5000 housing heat up during operation. These temperatures may exceed 60 °C. There is a danger of burn injury.



This device was **NOT** developed to power life-sustaining medical devices. The Sunny Backup 5000 may not be used in systems where a power outage could result in personal injury.



This device is suitable only for installation in enclosed spaces. Therefore, do not expose it to moisture, rain or direct sunshine (protection rating IP30).



The Sunny Backup 5000 has been designed for use at elevations of up to 3000 m above sea level. Please contact **SMA** Technologie AG before using the device at elevations above 3000 m.



A performance loss of 0.5 % per 100 m is to be expected starting at an elevation of 2000 m above sea level!



## 4 Installation

Take note of the required installation conditions listed below **before** mounting, installing and commissioning the Sunny Backup 5000 or the AS-Box.

When selecting the installation location for Sunny Backup systems, you must observe the applicable building regulations. Installation in necessary stairwells or in other escape routes require consultation with the respective fire protection authority!



### 4.1 Lifting/Moving

The Sunny Backup 5000 weighs 63 kg. Ensure that at least three people are available to install the device.

The Automatic Switch Box M weighs approximately 30 kg and the Automatic Switch Box L weighs approximately 40 kg. Ensure that at least two people are available to install the device.

The Automatic Switch Box XL weighs approximately 180 kg. It must be moved with a pallet truck, forklift, or similar transport device designed for heavy loads.

**Always wear personal protective equipment (protective clothing, gloves, safety boots) to reduce the risk of injury.**



The upper black ventilation flaps on the right and left side of the Sunny Backup 5000 can be removed for transportation; **carrying handles** are located under the flaps. The ventilation flaps are not mounted when the device is delivered. They are inserted after the device is installed (they snap on).



### 4.2 Unpacking

Before installing the Sunny Backup 5000 and the Automatic Switch Box make sure that all parts are included in the delivery.

- Carefully check the packaging, the Sunny Backup 5000 and the Automatic Switch Box for any signs of damage.
- Ensure that all parts are included in the delivery (see section 2.4 "Scope of Delivery Sunny Backup 5000" (Page 20)).
- Enter the type and serial number of the device into the "Warranty and Guaranty Conditions" form.
- Keep the documents in a location where they will be easy to find later.

- ➔ Remove the tape that covers both the outer and inner holes for the cable feed-throughs of the Sunny Backup 5000. It prevents foreign objects from entering the housing during transport.

If something is missing or the Sunny Backup 5000 or the Automatic Switch Box has been damaged during transport, contact **SMA Technologie AG** immediately. For more information, please see section 23 "Contact" (Page 183).

- ➔ Keep the packaging in case you need to return the Sunny Backup 5000, the Automatic Switch Box or their accessories.

### 4.3 Minimum Clearance

Air enters the Sunny Backup 5000 through the underside of the housing and then flows through the device before exiting through the air grills on top of the housing.

When installing the device, a minimum clearance of 20 cm at the sides and 10 cm above the housing must be provided to ensure adequate ventilation of the Sunny Backup 5000.

All external cables are connected through the underside of the housing. This requires a minimum clearance of at least 30 cm.

Operation of the device and reading the display is much easier when the Sunny Backup 5000 is installed with the display at eye-level with at least 50 cm clearance in front.

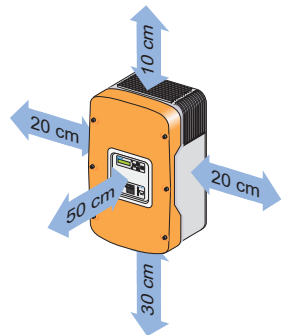

- ➔ When installing the Sunny Backup 5000 in smaller rooms, make sure that adequate ventilation is available. The device produces heat when operating that must be removed.
- ➔ Several Sunny Backup 5000s can be installed on top of each other without any problems since the active OptiCool ventilation system expels the heat to the side. The control of the integrated fans is temperature-dependent.

## 4.4 Wall Mounting

**Do not install the Sunny Backup 5000 and the Automatic Switch Box**

- on flammable construction materials,
- in areas where highly flammable materials are stored,
- in potentially explosive areas!



**Sunny Backup 5000 and the Automatic Switch Box may only be operated hanging vertically. Since condensation can build up, horizontal operation is not permitted!**



The Sunny Backup 5000 and Automatic Switch Box have considerable weight. Take this into account when choosing the installation location and method of installation.

Protect the Sunny Backup 5000 and the Automatic Switch Box from direct sunlight. High temperatures lead to lower performance of the battery inverter.

The ambient temperature must not be outside the  $-25\text{ °C}$  to  $+50\text{ °C}$  range.



To make the job easier, we recommend using the supplied wall bracket to mount the Sunny Backup 5000 and using a spirit level to ensure correct alignment. Fix the wall bracket using three screws (8 mm diameter).

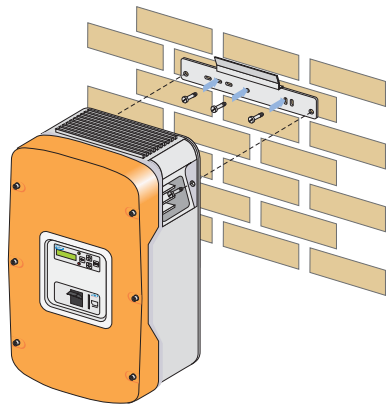

The following diagram shows in detail the spacing of the drill holes for installation of the wall bracket, and the minimum clearance for installation of two or more Sunny Backup 5000s. The two outer screws are used to keep the Sunny Backup 5000 securely attached to the wall.

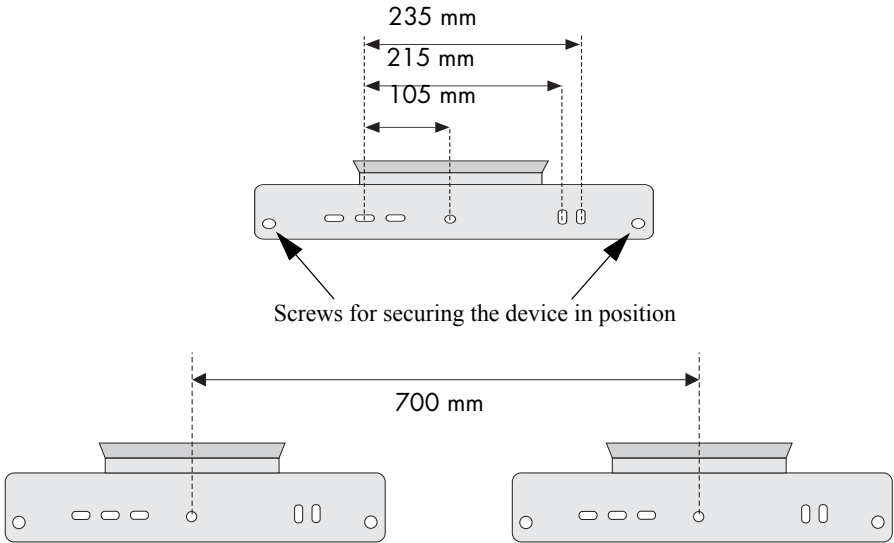



Keep to the following sequence when mounting the Sunny Backup 5000:

- Mount the wall bracket (1). To mark the positions to drill the holes, you can use the wall bracket as a drilling template.
- Now hang the Sunny Backup 5000 onto the wall bracket using its mounting plate so that it cannot be moved sideways.

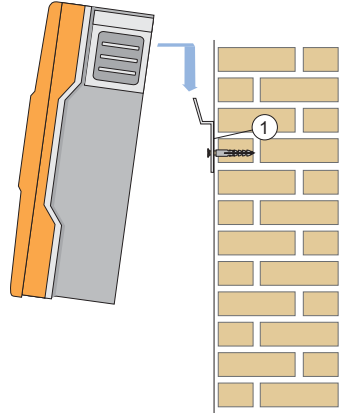

- Secure the Sunny Backup 5000 in position by screwing the supplied screw onto the wall bracket.

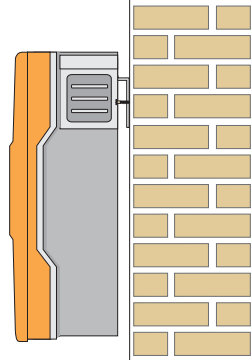

- Insert the upper right and left air grills (they only need to be snapped on). Make sure that the Sunny Backup 5000 is positioned securely on the bracket.

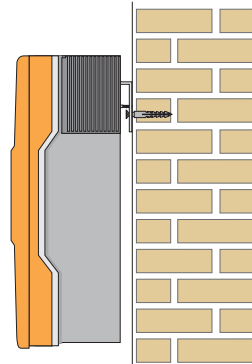

To fasten the Automatic Switch Box M or L to the wall, please use four screws (8 mm diameter).

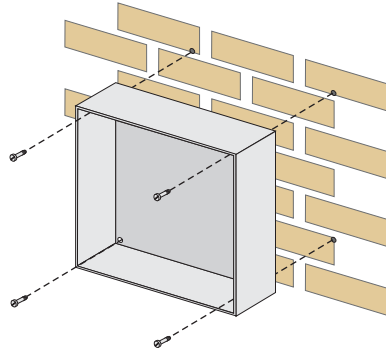

A ratchet with an extension (for fastening screws) makes the installation of the Automatic Switch Box M or L easier.

Due to its weight, the Automatic Switch Box XL must be placed on the provided base (height 200 mm).

## 4.5 Installing Batteries

Observe the battery manufacturer's installation instructions, as provided with the battery upon delivery, and the applicable standards and directives for installation of batteries (EN 50272-2).



**Please observe all safety instructions of relevance to the battery. The main ones that apply here are:**



- **Smoking prohibited! Do not allow open flames, embers, or sparks near the battery - danger of explosion and fire.**
- **Metal components of batteries are always energized. Therefore, do not place foreign objects or tools on the battery. Work carried out on the battery must always be performed with insulated tools - danger of short-circuiting.**
- **The electrolyte is extremely corrosive. During normal operation, it is not possible to accidentally touch the electrolyte. If the housing becomes damaged, exposed bonded electrolyte is just as corrosive as liquid electrolyte.**

Batteries must be accommodated in protected rooms, and sufficient ventilation of the installation location must be ensured. For battery systems which are only connected to one or more Sunny Backup 5000s, there is sufficient protection against direct and indirect accidental touching. It is not necessary to install such batteries in a separate battery room, or in a self-contained electrical facility.

The necessary air volume flow for ventilation of the room which accommodates the batteries is calculated as per EN 50272-2 under the following assumptions:

- Nominal battery voltage = 48 V
- Battery type: closed lead acid batteries (VRLA)
- Max. charging voltage = 2.4 V/cell

$$Q = 0.0096 \times C_{10} \text{ [m}^3\text{/h]}$$

with  $C_{10}$  as the 10 hour nominal capacity in [Ah].

The cross-sectional area of the ventilation inlets and outlets is calculated according to the following formula:

$$A = 28 \times Q \text{ [cm}^2\text{]}$$

In the area near the battery, it is not always ensured that the explosive gases are sufficiently diluted. For this reason, a clearance distance is to be observed in which no equipment which causes sparks or smoldering is permitted.

The clearance distance is calculated as follows:

$$d = 5.76 \times (C_{10})^{1/3} \text{ [cm]}$$

The following table indicates the necessary air volume flows, the ventilation cross-sectional areas, and clearance distances for various closed lead acid batteries.

Battery capacity [Ah]	Air volume flow for room ventilation [m <sup>3</sup> /h]	Ventilation cross-sectional area for natural air inlet and air outlet [cm <sup>2</sup> ]	Clearance distance [cm]
100 Ah	0.96 m <sup>3</sup> /h	27 cm <sup>2</sup>	27 cm
142 Ah	1.36 m <sup>3</sup> /h	38 cm <sup>2</sup>	31 cm
284 Ah	2.72 m <sup>3</sup> /h	76 cm <sup>2</sup>	38 cm
426 Ah	4.08 m <sup>3</sup> /h	114 cm <sup>2</sup>	44 cm



For closed lead acid batteries (liquid electrolyte) with the same charging voltages, the ventilation requirements are about 5 times higher than those stipulated here. As closed lead acid batteries are generally charged with even higher charging voltages, the requirements increase even further.

The batteries can either be installed directly on the ground, or on a special battery mount.



With closed batteries, installation in an acid-resistant collecting tray is to be provided for so that, in the event of a fault, leaking electrolyte cannot cause further damage.

Finally, install the battery bank in accordance with the installation instructions provided by the battery manufacturer.

## 5 Opening and Closing

Do not remove the Sunny Backup 5000's housing cover, or open the door of the Automatic Switch Box, unless during installation of the device, or maintenance or repair work.

**The Sunny Backup 5000 and the Automatic Switch Box may only be installed or opened by qualified personnel (qualified electrician).**



**Switch off the Sunny Backup 5000 and disconnect it, along with the Automatic Switch Box, from all voltage sources (battery, grid, generator) (see sections 9.2 "Stopping" (Page 82) and 9.3 "Deactivation" (Page 83)).**

**Wait 5 minutes.**

**Ensure that the system cannot be accidentally switched on again.**

### 5.1 Opening and Closing of the Sunny Backup 5000

#### Opening the Device

Proceed as follows:

1. Loosen the six hexagon socket screws on the front side of the Sunny Backup 5000, in order to remove the cover.
2. Remove the six hexagon socket screws.
3. Carefully and evenly pull the housing cover until it comes free from the housing.
4. Store the service access cover in a safe place while mounting, installing or repairing the device.

#### Closing the Device

When closing the Sunny Backup 5000, make sure that the original tooth lock washers are under the six hexagon socket screws. They secure the ground connection of the cover.



Before installing the housing cover of the Sunny Backup 5000, ensure that all cables are properly laid and that all tools have been removed from within the housing (see section 6 "Electrical Connection" (Page 39)).

1. Starting from the front, place the cover evenly on the housing.
2. Attach the housing cover onto the Sunny Backup 5000 using the six hexagon socket screws. Tighten the screws evenly and firmly.

## 5.2 Opening and Closing of the Automatic Switch Box

### Opening the Device

Proceed as follows:

1. Undo the two fasteners on the Automatic Switch Box door, using the (double-bit) cabinet key provided, with a 90° turn to the right.
2. Open the door.

### Closing the Device

Before closing the Automatic Switch Box door, ensure that all cables are properly laid and that all tools have been removed from within the housing (see section 6 "Electrical Connection" (Page 39)).

1. Smoothly push the door closed.
2. Close the two fasteners on the Automatic Switch Box door, using the (double-bit) cabinet key provided, with a 90° turn to the left.

## 6 Electrical Connection

The electrical installation of the Sunny Backup 5000 and the Automatic Switch Box must be made by qualified personnel only (qualified electrician). Before beginning to install your Sunny Backup 5000 and the Automatic Switch Box, identify any potential hazards and take any necessary precautions (see section 3 "Safety Instructions" (Page 25)).



If the device is connected incorrectly, a significant danger of injury or death arises and damage to the device, system or plant may also result.



All cables are fed through the feed-throughs on the underside of the device (see following figure) and connected to the appropriate connection terminals inside the Sunny Backup 5000.

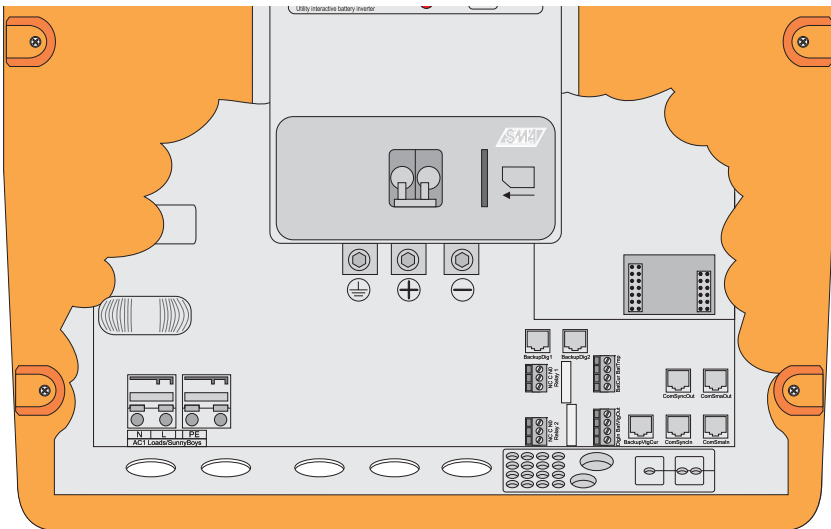

Use the provided cable screw connections to fasten the cables inside the Sunny Backup 5000 housing in a manner conforming to the appropriate standards. The metric-thread cable screw connections guarantee a dust-free and waterproof installation of the cables in the housing and also provide strain relief for the cable connection. Close all unused openings in the housing using the appropriate dummy plugs.

Obtain an overview of the different components and connection areas of the Sunny Backup 5000 (see section 2.2 "At a Glance" (Page 18)).

Detailed installation descriptions of the connections are provided in the following sections:

- Grounding (section 6.1)
- DC connection (section 6.2)
- AC connection (section 6.3)
- Battery temperature sensor (section 6.4.1)
- Communication for multi-device connection (section 6.4.3)
- Multi-function relay 1 and 2 (section 6.4.4)
- External communication (section 6.5)
- GenMan connection (section 6.6)
- Automatic Switch Box connection (section 6.7)

## 6.1 Grounding



In stand-alone configurations, the (protective) ground of the Sunny Backup 5000 and its individual components must be wired as a TN grid only. All valid standards and guidelines must be taken into account!



**Before commissioning the Sunny Backup 5000, it must be externally grounded according to the relevant regulations.**

**The N connection of the Sunny Backup 5000 has NOT been connected with PE by default. However, since a connection between N and PE is required for correct operation, this must be done outside of the device (see section 6.7.3 "Supply Line (X1/Load Meter)" (Page 67)).**



External grounding of the negative pole of the batteries is possible because the batteries and the grid side are galvanically isolated within the Sunny Backup 5000. In this case, make sure that the high currents that may occur under fault conditions can be adequately discharged.

If a connection is required, then this must be made externally by an installer.

The DC grounding conductors must be connected to the connection labeled "Ground". The grounding cable is installed in five steps:



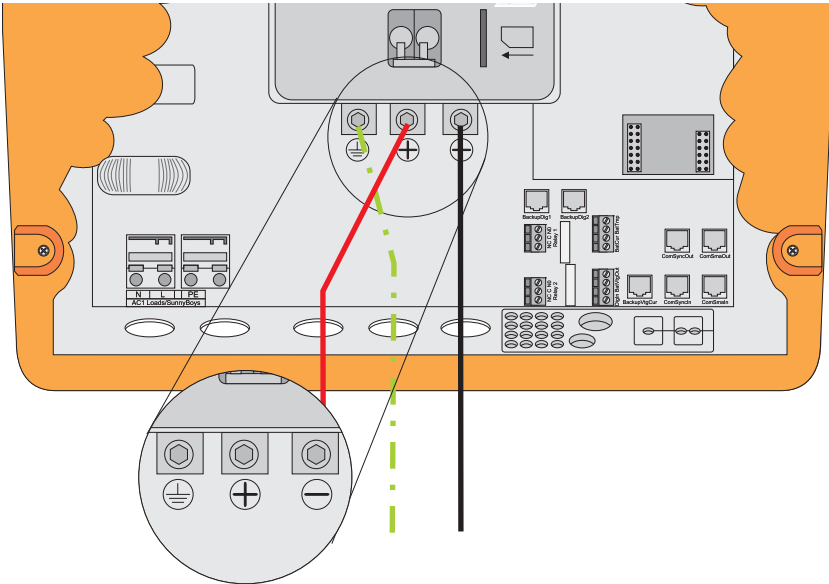

1. Loosen the cable screw connection on the device.
2. Thread the grounding conductor through the cable screw connection.
3. Remove the protective insulation from the conductor and fit a suitable ring cable lug to the exposed end of the conductor.
4. Install the cable screw connection at the second cable feed-through from the right.
  - Insert the metric-thread cable screw connection into the feed-through opening.
  - Screw the counter nut onto the cable screw connection thread inside the housing and tighten it.
5. Attach the conductor with the ring cable lug to the ground connection terminal and tighten the screw firmly (torque 4.0 Nm to 5.7 Nm).

### Calculating the Required Grounding Cable Cross-section

**SMA** Technologie AG cannot calculate generally valid values for the required cross-section of the grounding cable for external grounding of the battery. The conductor dimensions depend on the type and size of the battery connected, the external fuse (DC side) and the material used in the grounding conductor.

Exact calculation of the grounding conductor cross-section must take account of the regionally applicable standards and guidelines (e.g IEC 60364 Electrical Installation of buildings).



The required cross-section of a (copper) grounding conductor can be calculated using the following formula. Trigger times, e.g. for the integrated DC circuit breaker, of about 25 ms are typical for short-circuit currents between 2000 A and 10000 A.

$$S = \frac{\sqrt{I_{SC}^2 * t}}{143}$$

$t$  = interruption time in seconds  
 $I_{SC}$  = maximum battery current (short-circuit current) in amperes  
 $S$  = conductor cross-section in mm<sup>2</sup>

A grounding conductor of 16 mm<sup>2</sup> cross-section is thus adequate for short-circuit currents up to 10000 A.

## 6.2 DC Connection

### 6.2.1 Safety Precautions/Conditions

Connect a suitable battery to the DC side (see section 21 "Technical Data" (Page 175)). DC must be connected observing all valid regulations (e.g. DIN EN 50272-2, Safety requirements for secondary batteries und battery installations).



**All safety and maintenance instructions provided by the battery manufacturer must be heeded.**



**Use appropriate (insulated) tools for installation and wiring of the batteries (danger of short circuits and arcing).**



**When connecting the battery, ensure that the cable has sufficient cross-section and that the connections have the correct polarity.**



The battery cables should be as short as possible. Long cables and insufficient cable diameters reduce the system efficiency as well as the overload capabilities. Do not lay the battery feed cables under plaster or in armored plastic pipes. Large currents flow through the battery cables so that they can become very warm.

## 6.2.2 Cable Protection

If you connect the batteries to the Sunny Backup 5000 in a ground-fault proof, short-circuit proof manner, and if the maximum short-circuit current is lower than 10,000 A, you do not need any additional DC line circuit breakers. Otherwise, you should use an external battery fuse, e.g. SI BatFuse with 250 A, which should be installed as close to the battery as possible.

## 6.2.3 Connection

There is a "DC -" and a "DC +" connection available for each ring cable lug (max. 70 mm<sup>2</sup>) for the battery feed cables in the Sunny Backup 5000.

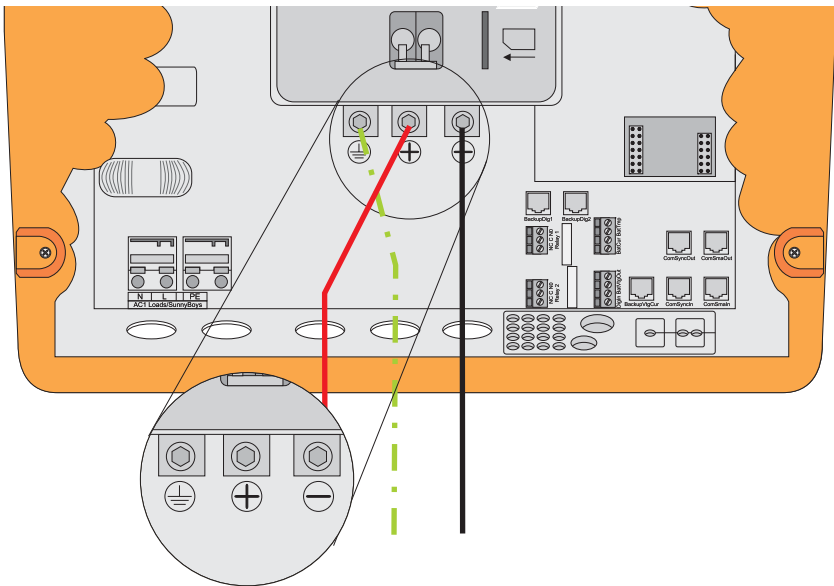

Install the DC connections in the following sequence:

1. Loosen the cable screw connections on the device.
2. Thread the conductors through the cable screw connections.
3. Remove the protective insulation from each conductor and fit a suitable ring cable lug to the exposed end of the conductor.
4. Install the cable screw connections with the M32/M25 adapter piece (included in delivery) for "DC -" at the middle cable feed-through, and for "DC +" at the right-hand cable feed-through.
  - Insert the metric-thread cable screw connection into the feed-through opening.

- Screw the counter nut onto the cable screw connection thread inside the housing and tighten it.
5. Attach the "DC –" conductor with the ring cable lug to the "DC –" connection and tighten the retaining screw firmly (torque 4.0 Nm to 5.7 Nm).
- Then attach the "DC +" conductor with the ring cable lug to the "DC +" connection and tighten the retaining screw firmly (torque 4.0 Nm to 5.7 Nm).



**Only connect the external fuse/battery cables to the battery after all other installation work is finished.**

## 6.2.4 Battery Connection Box (SBU-CON.33)

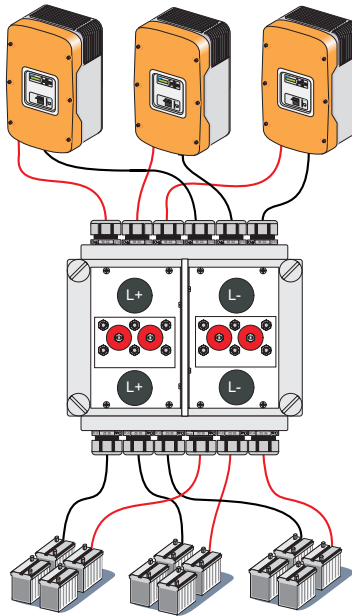

The SBU-CON.33 allows you to connect several Sunny Backup 5000 devices and batteries. For installation and connection, proceed as follows:

1. Attach the provided wall mounts to the SBU-CON.33.
2. Attach the SBU-CON.33 to the wall using suitable screws.
3. Remove the nuts and locking washers from the required connection bolts.
4. Feed the battery cables and Sunny Backup 5000 cables through the M32 screw connections into the box, and attach them to the connection strips.

**Ensure that the polarity is correct - danger of short-circuiting.**



5. Tighten the M10 conduit lugs with the prescribed torque (4.0 Nm to 5.7 Nm).
6. Apply the provided dummy plugs to all unused screw connections.
7. Tighten all screw connections.

Close the cover of the SBU-CON.33.

The maximum cable cross-section which can be fed into the SBU-CON.33 is 70 mm<sup>2</sup>.

The maximum current-carrying capacity is 3 x 160 A.

If there are several batteries in one system, connection must occur via the SBU-CON.33.



## 6.3 AC Connection

The Automatic Switch Box is connected to AC1 at the Sunny Backup 5000, with a three-conductor connection (see section 6.7.4 "Sunny Backup 5000 (X2/Sunny Backup)" (Page 68)).

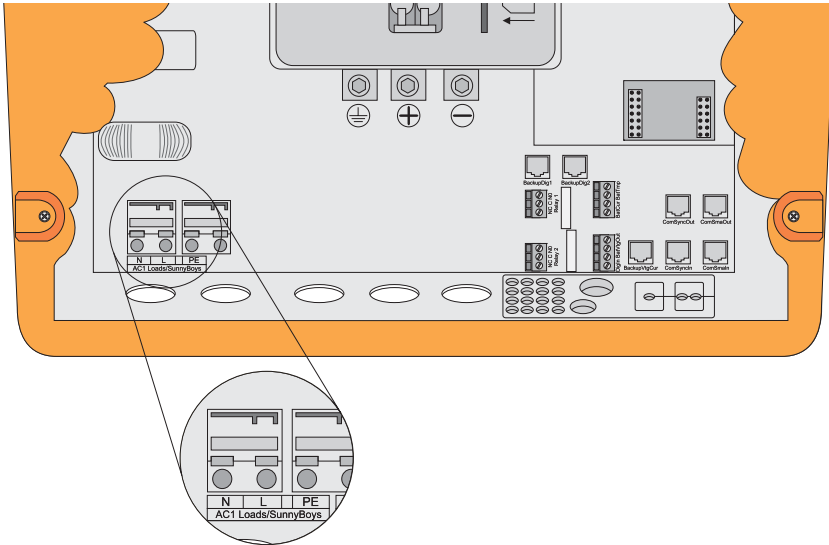

1. Sheathe the cable screw connection over the three-conductor cable and then insert the conductor into the housing of the Sunny Backup 5000.
2. Install the M25 metric-thread cable screw connection (included in delivery) on the "AC1 - Loads/Sunny Boys" cable feed-through.
  - Insert the cable screw connection thread into the cable feed-through opening.
  - Screw the counter nut onto the cable screw connection thread inside the housing and tighten it.
3. Remove the protective insulation from each of the three wires.
4. Install the three wires PE, N and L onto AC1: Following the specified sequence, insert the appropriate wire into the appropriate PE, N or L "AC1 (Loads/Sunny Boys)" spring-type terminals.

## 6.4 Additional Connections

For installing the connections described below, feed the cables through the specified holes in the rubber terminal block. Plugs for sealing the RJ45 communication cable for internal and external communication are provided in the rubber terminal block upon delivery. Combining plugs allows you to establish 0 to 4 feed-throughs (2 plugs without a feed-through, 1 with 1 feed-through and 2 with 2 feed-throughs). Remove any of these to connect the communication cable.

### 6.4.1 Battery Temperature Sensor

The battery temperature sensor measures the temperature of the connected battery. This is necessary since the optimum charging voltage for a battery strongly depends on the temperature. Further information is provided in section 14.4 "Charge Control" (Page 117).

A battery temperature sensor must be connected for operating the Sunny Backup 5000 (included in the delivery).



In case of a fault (short circuit, cable break), the Sunny Backup 5000 operates in a safe setting, which over time leads to insufficient battery charging. A warning indicating that the defective battery temperature sensor should be replaced immediately is shown on the display.

**Only use the battery temperature sensor provided with the delivery.  
Never drill any holes in any part of the battery to mount the sensor.**



A battery temperature sensor is provided with each Sunny Backup 5000. Only one battery temperature sensor, which is connected to the corresponding master, is required for a cluster. (The terms "cluster", "master", and "slave" are defined in section 24 "Glossary" (Page 184).)

Fasten the battery temperature sensor to the outside of one of the battery cells. Select a location if possible between two cells, but near the middle of the battery bank as a whole, because this is where the most heat is produced during operation.



Proceed as follows when connecting the battery temperature sensor:

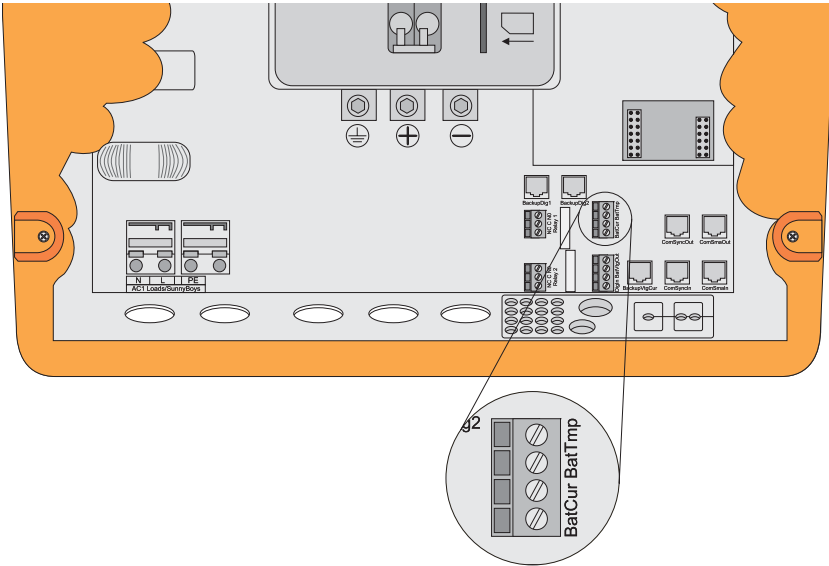

1. Pierce a hole in the rubber terminal area at the corresponding position.
2. Starting from the outside, feed the cable with cable end sleeves through the hole.
3. Insert one wire with the cable end sleeves in each of the "BatTmp" connection terminals of the provided 4-pole print terminals and tighten the screws of these terminals.



The polarity of the two conductors has no influence on the function of the battery temperature sensor.

4. Insert the 4-pole print terminal into the "BatTmp" socket.



## 6.4.2 Battery Current Sensor

In addition to the internal measurement, the Sunny Backup 5000 provides the possibility to measure the battery current via a shunt.

**The battery current sensor is obligatory in case that DC generators and DC consumers shall be connected. Only one battery current sensor connected to the respective master is required for a cluster.**



When connecting the battery current sensor proceed as follows:

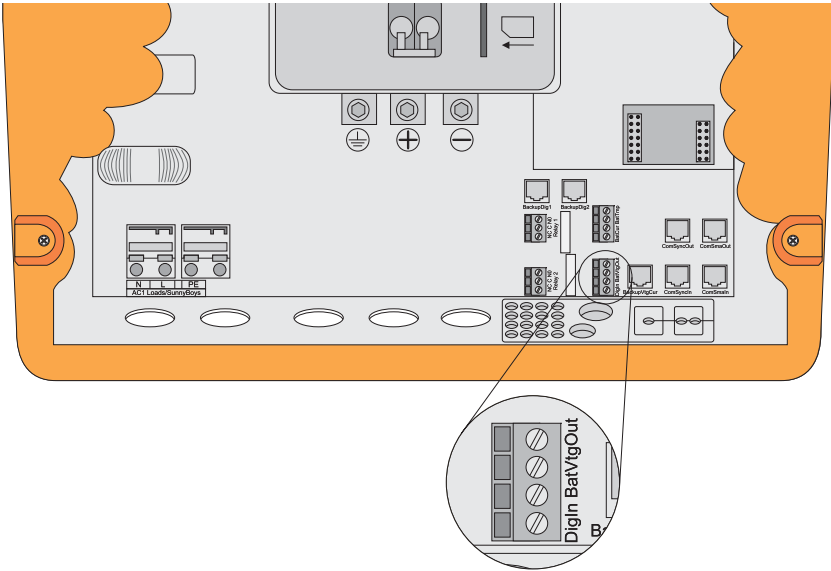

1. Pierce a hole in the rubber terminal area at the appropriate position.
2. Starting from the outside, feed the cable with the cable end sleeves through the hole.

The battery current sensor must be looped around the negative pole of the battery. The side of the shunt that is connected to the Sunny Backup 5000 must be connected to the "BatCur+" connection terminal.



If the battery current sensor is connected as described above,

- *positive battery current means that the battery is discharging (current from the battery)*
- *negative battery current means that the battery is charging (current into the battery)*

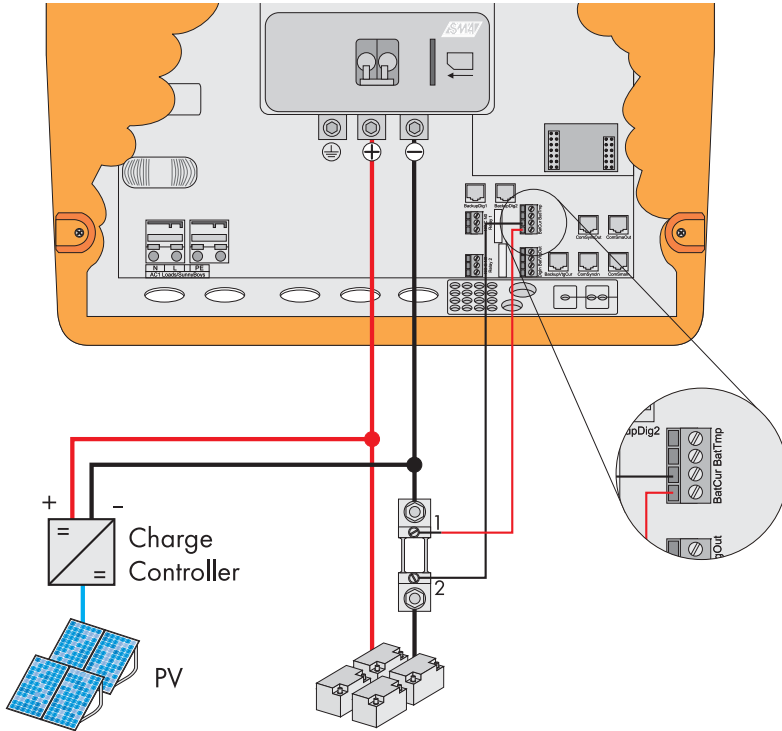

Charge controller and PV in the illustration above are only examples!

3. Insert one wire, each, with the cable end sleeve into the "BatCur" connection terminal of the 4-pole terminal included in delivery and tighten the terminal screws firmly.
4. Insert the 4-pole terminal into the "BatCur" socket.



Make sure to use intrinsically safe cables to connect the battery current sensor. "Intrinsically safe" means here that the cable is double-insulated and that the wire melts but the insulation remains intact in the event of a short circuit. In addition, the cable is not combustible. In order to avoid measuring errors, make sure to use twisted cables.

When connecting a battery current sensor to the Sunny Backup 5000 the device-internal offset must be set. This is only possible when you are in the installer level and the Sunny Backup 5000 is in standby mode.

Proceed as follows:

- Connect a short-circuit bridge (e. g. a piece of wire) to the "BatCur+" and "BatCur-" terminals instead of your battery current sensor.
- Use the "225.01 BatCurSnsTyp" parameter in order to set which type (None/ 50mV/60mV) you will use. After a sensor type has been set (50 mV/60 mV) other parameters (02, 03 and 04 in the menu 225# Battery Current Sensor) will be activated.
- Using the "225.02 BatCurGain60" and/or "225.03 BatCurGain50" parameter set the maximum current value of the battery current sensor used (e. g. 400 A/ 60 mV).
- Close and start the Sunny Backup 5000 as described in the manual.
- Change to "225.04 BatCurAutoCal" and set "Start". The Sunny Backup 5000 conducts an automatic calibration.
- Check the offset failure with the "120.06 TotBatCur" parameter. It should be (approximately) zero.
- Open the Sunny Backup 5000. Remove the short-circuit bridge connected to the "BatCur+" and "BatCur-" terminals. Connect the battery current sensor instead of the short-circuit bridge.

The current shunt can be ordered from SMA (SMA order number „SI-SHUNT xxx“).



### 6.4.3 Communication for Multi-device Connection

To increase its performance, the Sunny Backup 5000 can be connected in a 3-phase system with other Sunny Backup 5000 devices. The devices communicate with each other through an RJ45 communication cable.

The RJ45 communication cable is a Cat5e-FTP patch cable.





Each Sunny Backup 5000 device is delivered with one black and one white RJ45 communication cable.

You require the black cable to establish (internal) communication between several Sunny Backup 5000 devices. If you only have one Sunny Backup 5000 in your cluster, the cable is not required.

The white cable is used for external communication (via RS232 or RS485), see also section 6.5 "Interface for External Communication" (Page 58).



Make sure that you have selected a multi-phase configuration in the Quick Configuration Guide (see section 8 "(First) Commissioning" (Page 77)).

Proceed as follows when installing the communication cable:

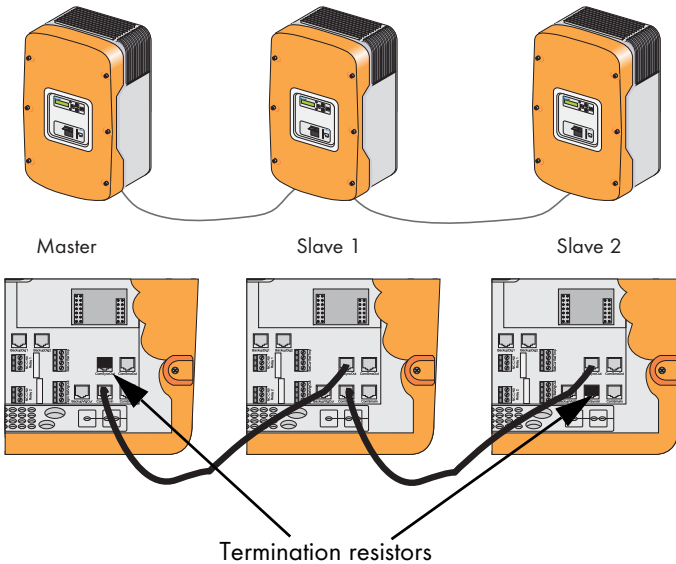

1. Remove the left of the two plugs in the rubber terminal area.
2. Starting from the outside, feed the RJ45 cable through the hole.
3. Insert the RJ45 plug into the "ComSyncOut" socket. The terminator plug remains in the "ComSyncIn" socket.

4. This cable goes into the "ComSyncln" socket in the next Sunny Backup 5000. Any other additional cable would be inserted into the "ComSyncOut" socket and lead to the next Sunny Backup 5000 (there in the "ComSyncln" socket). When you have completed this, insert the terminator plug into the "ComSyncOut" socket.
5. Wrap the rubber plug (depending on the number of cables with one or two feed-throughs, see 2.4 "Scope of Delivery Sunny Backup 5000" (Page 20)) around the cable.
6. Reinsert the plug in the opening provided in the rubber terminal block.

## 6.4.4 Multi-function Relay 1 and 2

The Sunny Backup 5000 provides you with several options to control internal and external operations. For this purpose, two multi-function relays are integrated into the device with which you can assign functions via the menu 241# using the Rly1Op and Rly2Op parameters (see section 16 "Relay" (Page 133)).

The relays are changeover contacts. They have both a break contact as well as a NO contact.

The relay functions are listed as NO contact functions, in other words, the contact is closed if the relay is activated by selecting the function. For the exception "Alm" (alarm), the relay has a break function. This means that the relay is normally activated and opens the contact. It is only deactivated when a fault occurs and then closes the contact (and thus activates a warning light, for example).

You can only assign one function to each relay. In clusters, the relays of the slaves can also be used. They are set using the master.



Proceed as follows when installing the relay connections:

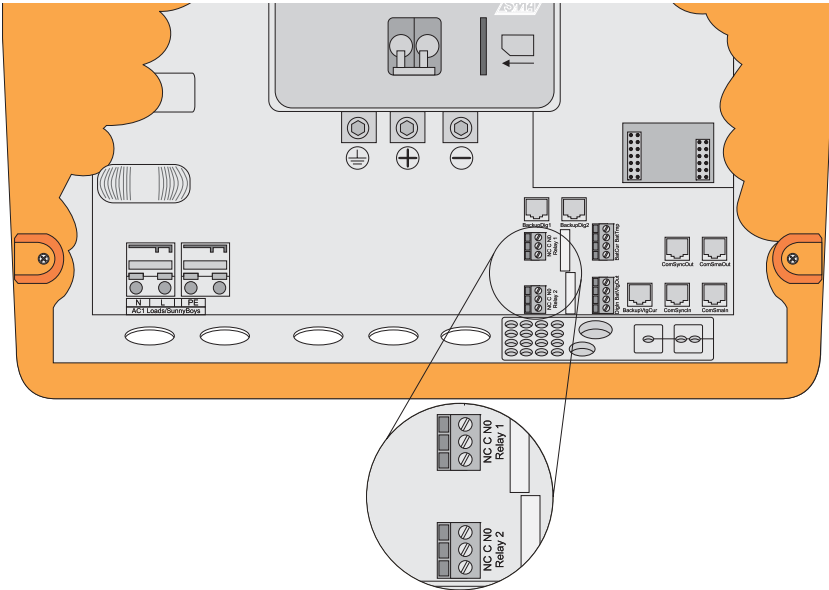

1. Pierce a hole in the rubber terminal area at the corresponding position.
2. Starting from the outside, feed the cable with cable end sleeves through the hole.
3. Insert the wires with the cable end sleeves in the "Relay1" or "Relay2" connection terminals of the provided 3-pole print terminals and tighten the screws of these terminals. The pins have the following meaning:
  - NC: Normally closed (closed when in standby)
  - C: Contact (operating contact)
  - NO: Normally opened (open when in standby)
4. Insert the 4-pole print terminal into the corresponding socket.

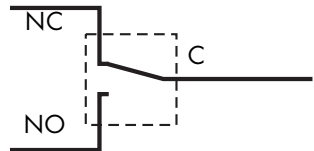

Information on the switching capacities of the relays is provided in section 21 "Technical Data" (Page 175).

## Load Shedding

The Sunny Backup 5000 can automatically switch off loads to protect the batteries from deep discharge. To do so, an external (AC or DC) power contactor must be installed between the Sunny Backup 5000 and the loads (see also section 2.6 "Accessories (Optional)" (Page 22)).

If a relay is used for load shedding, the loads will no longer be supplied with electricity in the event of a fault in the Sunny Backup system, even if the grid is available.



## Generator Start

The Sunny Backup 5000 can control generators. It supports generators that can be started and stopped by a single contact and generators that require more than one contact (in combination with the optionally available generator manager (GenMan)).

The two relays, which are integrated in the Sunny Backup 5000 and are freely programmed, assume both tasks (depending on the programming in menu 261#, parameter Rly1Op and Rly2Op); see also section 16 "Relay" (Page 133).

The AutoGn function is pre-configured for Relay1 and the AutoLodSoc function is pre-configured for Relay2.



## 6.4.5 BatVtgOut Power Supply

The battery voltage is conducted to the outside at these terminals. The battery voltage is fused at both poles by PTC resistors (max. 0.75 A) and can fluctuate depending on the battery status. This connection can, for example, be used to supply a DC contactor for load shedding.

Proceed as follows when connecting the power supply:

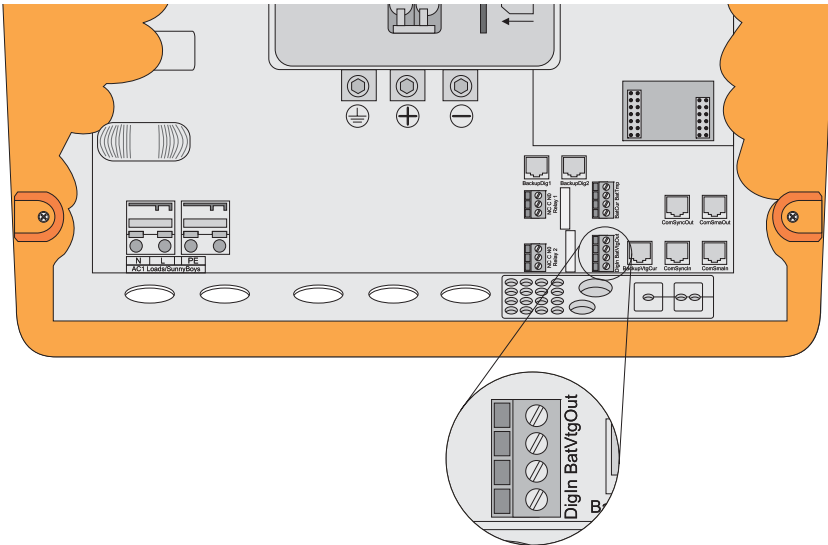

1. Pierce a hole in the rubber terminal area at the corresponding position.
2. Starting from the outside, feed the cable with cable end sleeves through the hole.
3. Insert one wire with the cable end sleeves in each of the "BatVtgOut" connection terminals of the provided 4-pole print terminals and tighten the screws of these terminals.
4. Insert the 4-pole print terminal into the "BatVtgOut" socket.



## 6.4.6 Digital Input, DigIn

These terminals are used as a digital input, for example, the feedback contact for the GenMan (GenRn) is connected here.

Proceed as follows when connecting the digital input:

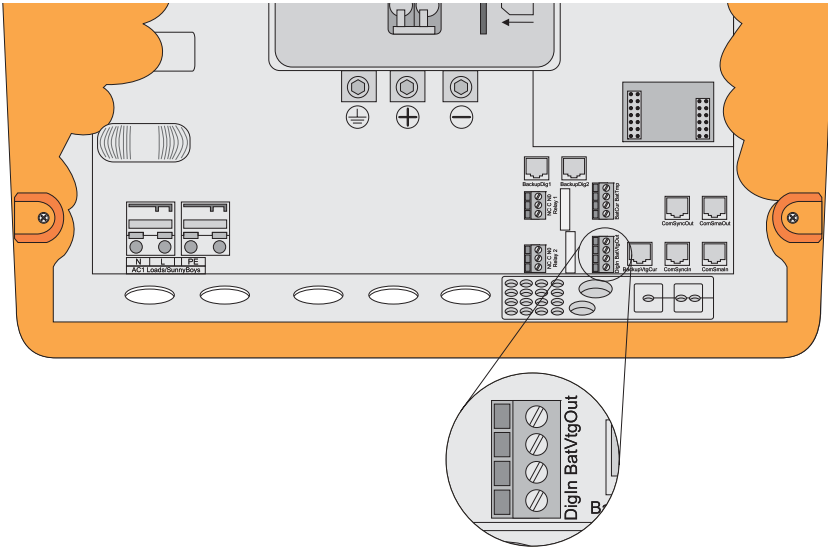

1. Pierce a hole in the rubber terminal area at the corresponding position.
2. Starting from the outside, feed the cable with cable end sleeves through the hole.
3. Insert one wire with the cable end sleeves in each of the "DigIn" connection terminals of the provided 4-pole print terminals and tighten the screws of these terminals.
4. Insert the 4-pole print terminal into the "DigIn" socket.

For more information on connecting and operating the GenMan, please see the corresponding product documentation.



## 6.5 Interface for External Communication



**Installation or replacement of the communication interface is only to be carried out by a qualified electrician.**

The communication interface is used to communicate with SMA communication devices (e.g. Sunny Boy Control, Sunny WebBox) or a PC with appropriate software (e.g. Sunny Data Control). Depending on the selected communication interface, up to 50 inverters can be detected at once. Detailed information on this topic can be found in the communication device manual, the software, or on the Internet at [www.SMA.de](http://www.SMA.de).

The following communication interfaces can be built into the Sunny Backup 5000:

- RS232
- RS485
- RS485 & CAN



Piggy-Backs are only required at the master device (single point of operation).

The RS485 & CAN Piggy-Back is necessary in order to construct larger systems with more than one cluster. Only the master devices of each cluster require these Piggy-Backs.

Alongside the CAN bus, which is solely responsible for communication between the master devices, and for which RJ45 sockets are situated directly on the Piggy-Back, this Piggy-Back performs the function of a normal RS485 Piggy-Back.



Communication via Powerline/Powerline modem (NLM) is not possible in Sunny Backup systems.

The detailed wiring diagram for the individual communication interfaces can be found in the communication device manual. This wiring diagram includes the following information:

- Details on the required cable type
- Which of the inverter's connections are used
- Whether or not the communication cables must be terminated
- Whether the protective earth needs to be connected to the cable shield

The next pages will describe the following:

- The housing feed-throughs for the communication interface

- The permitted cable route in the Sunny Backup 5000
- The location of the sockets for connecting the communication wires
- The location of the interface port

## 6.5.1 Connection of the Interface

When opening the Sunny Backup 5000, follow all the safety instructions as described in section 3.2 "Potential Hazards" (Page 26).



Electrostatic discharges are an acute danger to the Sunny Backup 5000 and to the communication interface. Ground yourself by touching PE before removing the communication interface from the packaging, and before touching any components within the Sunny Backup 5000.



Read the communication device manual before beginning installation work. Further wiring details can be found there.



1. Remove the right plug of the two plugs in the rubber terminal area.
2. Thread the cable through the cable feed-through (A) from the outside.
3. Insert the cable into the upper socket.
4. Place the plug around the cable.
5. Reinsert the plug in the opening provided in the rubber terminal block (A).
6. Lay the cable in area (B) as shown in the following figure.
7. The three pins that you are to use are specified in the operating manual for the communication device. The following table displays the assignment of the specified pins for the pins of the RJ45 socket.

Communication device pin (Sub-D 9-pole)	RS232	RS485	RJ45 socket
2	RXD	A (Data-)	3
3	TxD	–	–
5	GND	GND	2
7	–	B (Data+)	6

8. Terminate the Sunny Backup 5000 at RS485.  
In the Sunny Backup 5000, the RS485 data bus is terminated using a plug. This plug is already pre-installed in the Sunny Backup 5000. Please only remove the plug if you would like to connect another Sunny Backup 5000 device or a communication device.



On the circuit board above the RJ45 socket is a red sliding switch (C) with which you can switch from RS485 to RS232 communication. The default setting is RS485 (downward position).

9. Plug the communication interface into the board (D).
10. Close the Sunny Backup 5000 as described in section "Closing the Device" (Page 37).

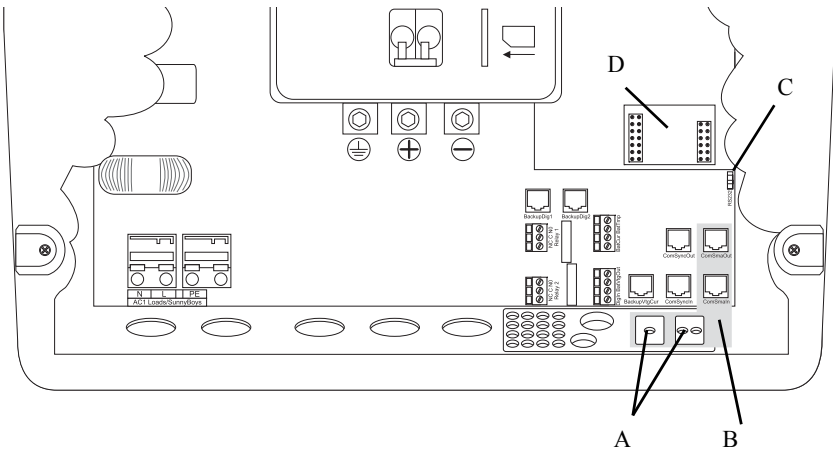

- A Housing feed-through in the base of the Sunny Backup 5000
- B Cable route (gray surface)
- C RS232 communication sliding switch
- D Interface port

## 6.5.2 Data Transmission Speed

The Sunny Backup 5000 can communicate with external devices at a range of different data transmission speeds (1200 to 19200 bps). The "270.06 ComBaud" parameter must be set appropriately for this.

If Sunny Boys are connected to the communication bus, then the baud rate must be set to 1200 bps (factory setting). Observe the manufacturer's specification for all other devices.



The Sunny Backup 5000 uses the SMA-Net protocol for communication.

A detailed wiring diagram for the communication interfaces for the entire communication structure of your system can be found in the handbook for the communication device you have chosen.

## 6.6 GenMan Connection

When operating a Sunny Backup 5000 with GenMan, the following assignment of the interfaces or signals applies:

<b>Signal on GenMan</b>	<b>Signal on Sunny Backup 5000</b>
GenRq	Relay1, AutoGn function (see 16 "Relay" (Page 133))
GenRn	DigIn

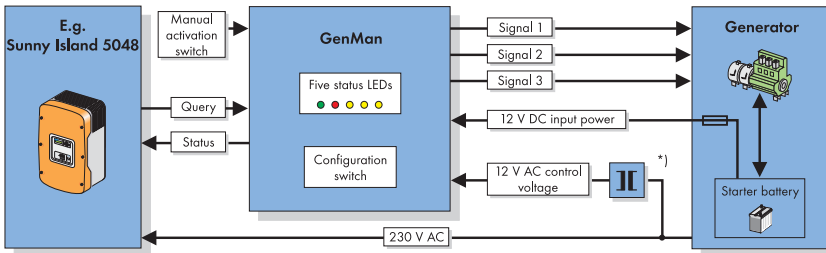

\*) Transformer included in GenMan delivery



The GenMan connection must occur at the master device!



For more information on connecting and operating the GenMan, please see the corresponding product documentation.

## 6.7 Automatic Switch Box Connection

The Automatic Switch Box is the central switching device of the Sunny Backup system. It is available in the following versions:

- Automatic Switch Box M: for single-phase backup systems with one Sunny Backup 5000
- Automatic Switch Box L: for three-phase backup systems with one Sunny Backup 5000 per phase
- Automatic Switch Box XL: for three-phase systems with high output (multicluster systems with up to four three-phase clusters).

All connection terminals for the external 400 V or 230 V AC cables are situated on the bottom row of the mounting plate. Only in the Automatic Switch Box XL are the X2 / Sunny Backup terminals and circuit breakers on the second level above the bolt clamps. The terminals are implemented either as spring-type terminals, or as bolt clamps, depending on the model. Some cables are also connected to fuse holders or line circuit breakers, which are also accommodated on the terminal strip.

All cables, except for the communication cables, are fed into the Automatic Switch Box from underneath. For this purpose, a plastic flange plate with membranes is situated on the underside of the housing. For the fully assembled communication cables (with RJ45 plugs), a number of plug feed-throughs are provided in the side panel.

**Make sure that the feed-throughs used are tightly sealed, and that all unused feed-throughs are closed.**



### 6.7.1 Feeding in the Energy Cables

To feed in and connect the 400 V or 230 V AC cables, proceed as follows:

- Select a feed-through opening which is suitable for the cable diameter, and strip away a length of the cable's outer sheath which corresponds to the length to be installed in the AS-Box.
- Use a sharp pin-shaped object to prick a hole in the rubber membrane at the feed-through position. Do not cut it with a knife, or with diagonal cutting pliers.
- Thread the prepared cable through the opening in the elastic membrane which is thus created. The membrane must tightly reseal around the cable sheath.
- Provide sufficient strain relief for the cable outside the Automatic Switch Box.
- Route the conductors to the connection terminals, and strip the cable end according to the connection type. For spring-type terminals, you do not need cable end sleeves, even with multi-strand or fine-strand cables. However, observe the stipulated length to be stripped (13–15 mm with 6 mm<sup>2</sup> spring-type terminals, and 18–20 mm with 16 mm<sup>2</sup> spring-type terminals).

- Connect the conductors to the provided connection terminals. For bolt clamps (only in Automatic Switch Box XL), you must first squeeze a conduit lug onto the stripped cable end before you can make these connections. Observe the tightening torque for bolt clamps (6–12 Nm).

## 6.7.2 Feeding in the Control and Measurement Cables

The control cables and measurement cables (hereinafter referred to as communication cables) which are provided with the Automatic Switch Box, and which have RJ45 plugs attached, are to be fed into a separate plug feed-through in the housing's side panel.



**The communication cables with plugs must not be fed through the plastic flange plate on the underside of the housing, even if this still has free membranes. Threading the plug through would cause the membrane to be widened excessively, and there would no longer be a tight seal around the thinner cable.**

**Do not feed the communication cables through the cable channel with 400 V or 230 V AC cables.**

For a single-phase system, you require two cables (one black and one red); for a three-phase system (with three or more Sunny Backup 5000s), you need four cables (one black and three red).



If the length of the provided cables is insufficient, use commercially available Cat5e FTP cables (single shield) with gold contacts.

To feed in and connect these communication cables, proceed as follows:

- Loosen the pre-mounted plug feed-through at the hexagon socket screws on the inside of the side panel, pull off the metal retaining bracket, and completely remove the feed-through element through the installation opening.
- Loosen the two screws on the feed-through element, and separate the two plastic components. In so doing, take care not to lose the loose rubber inserts, or the clamped-in plastic rods.
- The cables which are to be fed through must now be inserted (maximum three per feed-through) into the rubber inserts at the provided locations (rounded areas in the plastic components), with sufficient lengths of cable to reach from the feed-throughs to the appropriate connection points (RJ45 sockets on the circuit board). Insert the provided plastic rods to seal unused cable feed-throughs.
- Use cable ties to fasten the cables to the tothing provided at the feed-through.
- Place the two plastic components around the rubber inserts and screw them together.



- Now feed the cables through the installation opening into the Automatic Switch Box until the feed-through element protrudes into the installation opening.
- From the inside, push the feed-through's opposing retainer into the plugged-through element's corresponding slot, and refasten the assembly to the side panel using the hexagon socket screws.
- Take care not to route the communication cables directly beside 230 V AC cables.
- Route the cable ends to the RJ45 sockets on the circuit board, and insert the plugs into the appropriate sockets (see sections 6.7.10 "ComSync Communication Cable" (Page 72) and 6.7.11 "BackupVtgCur External Control Lines and Measurement Cables" (Page 72)).

The following diagram shows the connection plan of a three-phase system with a cluster (three Sunny Backup 5000s) at the Automatic Switch Box L. The individual cable connections are described in detail in the subsequent sections.

Three-phase Sunny Backup system

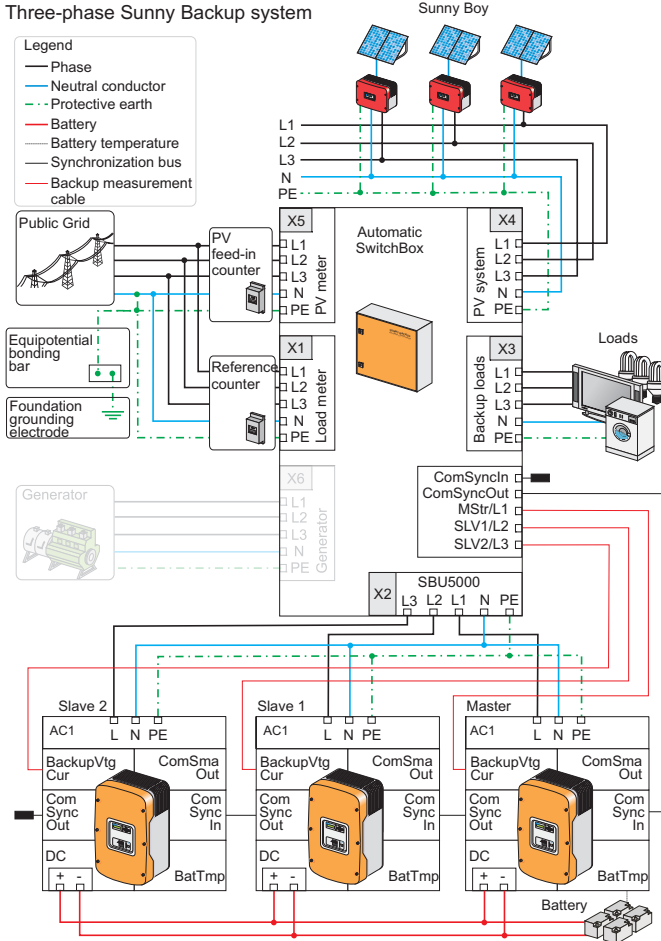

The Automatic Switch Box M differs from the diagram in that at terminal strips X2, X4, X5 and (if applicable) X6, instead of connections L1, L2 and L3, there is only one connection L. The AS-Box XL differs from the diagram in that at terminal strip X2, four of each of the connections L1, L2, L3, N and PE are present (for up to four Sunny Backup 5000 clusters, i.e., for up to twelve devices). The connection terminal strip X6 is only present on Automatic Switch Boxes which were ordered with a generator connection (order option, cannot be retrofitted).

### 6.7.3 Supply Line (X1/Load Meter)

Connect the X1 / Load Meter (L1, L2, L3, N, PE) connections to the system's electricity meter. The required cross-section of the cables depends on the upstream fuse outside the Automatic Switch Box. The maximum permissible back-up fuse is 63 A (for Automatic Switch Boxes M and L) or 160 A (for Automatic Switch Box XL). Cables with cross-sections of up to 16 mm<sup>2</sup> can be connected to the Automatic Switch Boxes M and L via spring-type terminals; the Automatic Switch Box XL has M8 bolt clamps for ring cable lugs and cable cross-sections of up to 70 mm<sup>2</sup>.

**When connecting the phase conductors to the connection terminals L1, L2 and L3 in three-phase systems, make sure that, on the grid side, they form a clockwise phase sequence in the specified sequential order. Check this before commissioning the system.**



The Sunny Backup system is only intended for use in TN grids!



**Do not install an RCD in the backup system's grid-side supply cable! Its protective function (voltage disconnection) would be cancelled out by the backup system, and it would also interrupt the neutral conductor's ground connection.**



**Make sure that in the backup system's supply line, there is no switching element which interrupts the neutral conductor. The backup system requires a grounded neutral conductor. There must always be a ground connection, as otherwise, in stand-alone operation, a TN grid would no longer be formed, so other protective measures would be necessary.**



**Make sure that the PEN conductor on the grid side is grounded within the system (before or at the point of separation into N and PE conductors), e.g., connection from the house connection box to the equipotential bonding bar.**



Three phases can also be routed to the loads via the Automatic Switch Box in single-phase backup systems (Automatic Switch Box M only) (see section 6.7.5 "Consumer System (X3/Backup Loads)" (Page 68)). In this case, also implement a three-phase supply line connection. If no three-phase loads are connected, you only require the grid connection at L1.

## 6.7.4 Sunny Backup 5000 (X2/Sunny Backup)

Connect the X2 / Sunny Backup connection to the Sunny Backup 5000 inverter(s). In the Automatic Switch Box, every inverter connection is fused by a C 32 A line circuit breaker. This affects the required cable cross-section, as does the layout type.



**SMA Technologie AG** recommends that the cable to the inverter have a cross-section of  $6 \text{ mm}^2$  (e.g.  $3 \times 6 \text{ mm}^2$ ), as this is sufficient for all layout types with the fuse protection mentioned above.



**In multi-phase systems (Automatic Switch Boxes L and XL), it is imperative to ensure correct assignment of devices. The phases L1, L2 and L3 must form a clockwise phase sequence on the grid side. This must be ensured for the connection X1 (grid) and, if applicable, X6 (generator). When connecting the cables to the Sunny Backup 5000, assign the device which is configured as "master" to phase L1, the device configured as "slave 1" to phase L2, and the device configured as "slave 2" to phase L3.**

In a multicluster backup system (Automatic Switch Box XL), several Sunny Backup 5000 inverters are to be connected per phase. With this variant, no spring-type terminals are present in the Automatic Switch Box for connection of the phases. In this case, please attach the conductors directly to the corresponding line circuit breakers. These are assigned to terminal strip X2, and are labeled with phase identifiers.



**Connect just one inverter to each output (line circuit breaker).**

## 6.7.5 Consumer System (X3/Backup Loads)

The output cable for the consumer system is routed via fuses in the Automatic Switch Box. Connect the phase conductors to the fuses' screw terminals which are assigned to terminal strip X3 and which are labeled with phase identifiers. In terminal strip X3, spring-type terminals are provided for neutral and protective earth conductors.

The fuses are necessary in order to protect the output cable from overload in stand-alone grid operation. Note that in this case, the Sunny Backup 5000 inverters and the PV system can power the loads, and the upstream fuse on the grid side has no effect in this situation. Therefore, check the cable cross-section of the consumer system's supply cable, determine the required fuse size according to layout type and ambient conditions, and install appropriate fuse plugs.

The fuse plugs are not provided on delivery as they must be dimensioned specifically according to the respective system. For the Automatic Switch Boxes M and L, you require D02 fuse plugs; for Automatic Switch Box XL, you require NH00 fuse plugs.



Note the maximum permissible values as listed here: 35 A (Automatic Switch Box M), 63 A (Automatic Switch Box L) and 160 A (Automatic Switch Box XL).

In unfavorable constellations, it may occur that it is not possible to select whether to install the fuses as upstream or downstream fuses. This is unavoidable due to the complexity of the backup system with several feeding sources.



Three phases can also be routed via the Automatic Switch Box in single-phase backup systems (Automatic Switch Box M only). This means that also the phases L2 and L3 are routed through the grid isolation contactor, and in the event that the backup system is disconnected from the grid, they are also disconnected from the grid. However, feeding from the PV system, the Sunny Backup inverter and, if applicable, the diesel generator, occurs only via phase L1.

**Make sure that no three-phase loads (e.g. continuous-flow heaters, or 5-pole CEE plug sockets) are connected to the Automatic Switch Box's phase L1, unless the corresponding L2 and L3 phase conductors are also connected. Otherwise, in the event of grid failure, single-phase feeding of the three-phase load would occur, and thus a risk of personal injury would arise, as phases L2 and L3, which are not disconnected from the grid, would be feeding voltage into the grid in an improper manner! If only phase L1 is routed from the Automatic Switch Box to the loads, it may only be connected to single-phase loads.**



## 6.7.6 PV System (X4/PV System)

Connect your PV system to the connection terminal strip X4 / PV System. Due to the multitude of possible constellations (e.g. one inverter per phase, or several small inverters in parallel), the Automatic Switch Box is not intended to serve as a distributor cabinet and fuse box for the PV inverters.

The line circuit breakers (and, if applicable, RCD) prescribed in the manuals of the inverters used must be installed between the Automatic Switch Box and the PV inverters. Thus, the Automatic Switch Box only contains one single-phase or three-phase cable connection (L/N/PE or L1/L2/L3/N/PE).

In Automatic Switch Box M, cables with a cross-section of up to 6 mm<sup>2</sup> can be connected to the spring-type terminals; in Automatic Switch Box L, a cross-section of up to 16 mm<sup>2</sup>. In Automatic Switch Box XL, bolt clamps are available for larger cross-sections (up to 70 mm<sup>2</sup>).

The dimensioning of the output cable is to be selected according to the routing conditions and the upstream fuse on the grid side (see also X5 / PV Meter connection). For backup systems with a generator connection (order option), attention must also be paid to the fuse protection of the generator feed-in. If the generator feed-in at the X6 / Generator terminal strip has a greater fuse protection than the supply cable from the feed-in counter (upstream of X5 / PV Meter), then the output cable from X4 / PV System must be implemented with this higher fuse value.

With regard to short-circuit protection, the PV inverters and the Sunny Backup inverters do not need to be taken into account as, due to their design, they cannot endanger the cables if a short circuit occurs. In the event of a short circuit, only short-circuit currents from the grid, or from the diesel generator, require fuse protection. Overload protection is always guaranteed if, as can be assumed, the cables which you route to the PV system are designed for at least the feed-in power of the PV system.



**Only PV inverters, and no other feed-in generators, may be connected to the X4 / PV System terminal strip if the Automatic Switch Box is connected via X5 / PV Meter to a feed-in counter which is tariffed for PV power. It is also not allowed to connect loads to the X4 / PV System terminal strip, or to the cable which runs from this terminal strip to the PV system.**

## 6.7.7 PV Feed-in Counter (X5/PV Meter)

Connect the X5 / PV Meter connection to the feed-in counter for the PV system. The cross-section of the cables depends on the upstream fuse. Cables with cross-sections of up to 6 mm<sup>2</sup> can be connected to the Automatic Switch Boxes M and L; the largest permissible back-up fuse is 35 A.

It is not necessary to include a protective earth (PE) conductor in this cable, as the Automatic Switch Box is already connected to the system's equipotential bonding system with a larger cross-section, via grid connection X1 (Load Meter). If the supply cable from the feed-in counter includes a protective earth conductor, this can also be connected to the PE terminal at X5 / PV Meter.

Short circuit the connector X5/PV-Meter and X1/Load-Meter for the operation of a PV-system without feed-in meter (see figure below).

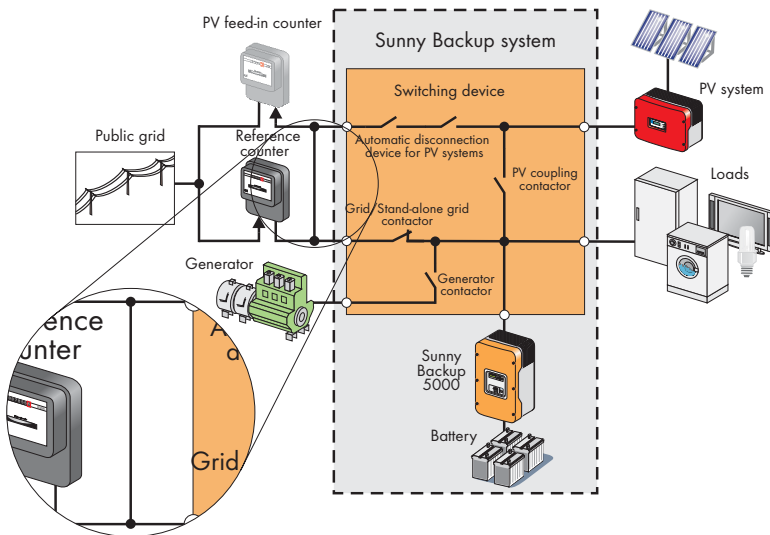

## 6.7.8 Generator (X6/Generator)

Connect the X6 / Generator connection with the diesel generator's connection box. With the Automatic Switch Box M, a single-phase generator (L/N/PE) can be connected; with the other models, a three-phase generator (L1/L2/L3/N/PE) can be connected. The connections L, or L1, L2 and L3 are situated on fuse sockets beside the X6 / Generator terminal strip. Spring-type terminals are available for neutral and protective earth conductors.

Select the required cable cross-section according to the generator's nominal output, and according to whether the generator has an output fuse. With the fuse, or fuses, to be inserted in the Automatic Switch Box, you protect the cable leading to the generator

against short-circuit currents from the grid, and against overload. Note that the rating of the fuse in the generator output can also have an influence on the rating of the cable leading to the PV system (see section 6.7.6 "PV System (X4/PV System)" (Page 69)).



If the diesel generator does not have an output fuse, you must implement the cable connection to the Automatic Switch Box in a ground-fault proof and short-circuit proof manner. Alternatively, it is advisable (especially if the cable routes are long) to use an additional fuse box near the generator.

### 6.7.9 Signal-controlled feeding (X7/Feed In Signal)

The grid feeding from the battery can, among other things, be controlled by an external, dry contact. This signal is sent, for example, by the energy supplier and can be received with a ripple control signal receiver. Connect the output of the ripple control signal receiver to the "Feed In Signal" connection terminal of the Automatic Switch Box (0 = no feed in; 1 = feed in). Set the "232.41 FedInMod" parameter to "Signal". Once the dry contact is closed, the Sunny Backup 5000 starts feeding the electricity (see also section 13.7 "Grid feeding from the battery" (Page 112)).

### 6.7.10 ComSync Communication Cable

The Automatic Switch Box is controlled by the Sunny Backup 5000 via a CAN bus. In multi-phase systems (Automatic Switch Box L), this occurs via the inverter which is configured as master; in multicenter backup systems (Automatic Switch Box XL), this occurs via the inverter which is configured as master of the main cluster.

Connect the ComSyncOut socket on the circuit board in the Automatic Switch Box to the Sunny Backup 5000's ComSyncIn socket, using the black RJ45 cable provided (see section 6.5 "Interface for External Communication" (Page 58)).



The CAN bus must be terminated at both ends with terminating plugs. For this purpose, the ComSyncOut socket on the circuit board in the Automatic Switch Box is already provided with a terminating plug ex works. In single-phase systems, the other end of the bus is situated at the connected Sunny Backup 5000, while in three-phase systems it is at the inverter which is configured as slave 2 of the main cluster.

### 6.7.11 BackupVtgCur External Control Lines and Measurement Cables

The Automatic Switch Box transfers voltage measurement signals and current measurement signals to the Sunny Backup 5000. In three-phase systems, each of the three inverters receives the signals relevant to the phase with which it operates. In multicenter backup systems (Automatic Switch Box XL only), these signals are to be routed to the main cluster's devices.



Connect the socket Mstr / L1 on the circuit board in the Automatic Switch Box to the Sunny Backup 5000's BackupVtgCur socket, using the red RJ45 cable provided (see section 6.5 "Interface for External Communication" (Page 58)). In three-phase systems, the inverter to use for this connection is the inverter connected to phase L1, which must also be configured as master.

In three-phase systems, use one of the provided red RJ45 cables to also connect the socket Slv1 / L2 on the circuit board in the Automatic Switch Box to the BackupVtgCur socket at the Sunny Backup 5000 which is connected to phase L2, and which is configured as slave 1, and also connect the socket Slv2 / L3 on the circuit board in the Automatic Switch Box to the BackupVtgCur socket at the Sunny Backup 5000 which is connected to phase L3, and which is configured as slave 2. In multicenter backup systems, these devices must be those of the main cluster.

**Take care not to mix up the cables. Any cables which have the same color are to be labeled at both ends before routing so as to avoid confusion when making the connections. If the phase sequence is connected incorrectly, the grid and the inverters form different rotating fields, which causes short circuits upon activation.**



## 6.7.12 Concluding Tasks

Check that all feed-throughs are tightly sealed, and that no unsealed openings remain.

Make sure that all of the cables which have been fed into feed-throughs are strain-relieved, and that the communication cables within the Automatic Switch Box cannot come into contact with stripped 230 V conductors.

For the power cables and measurement cables in three-phase systems, make sure that the phase sequences of the inverter connections match.

Install all necessary fuses, and close the Automatic Switch Box.

When routing cables between a Sunny Backup 5000 and the Automatic Switch Box, only permanent cable installation and strain-relieved cables are permissible. Use sheathed cables (doubly insulated conductors)!



## 7 Control Elements

In order to commission the Sunny Backup 5000, you should familiarize yourself with its operation beforehand. The individual control elements can be seen in the following figure.

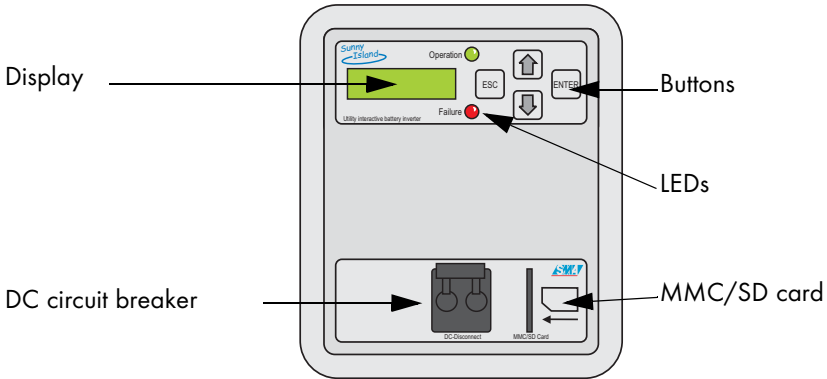

### 7.1 Display Messages

The Sunny Backup 5000 display has two lines each with 16 characters. For details, please see section 10.6 "Display Messages (Overview)" (Page 96).

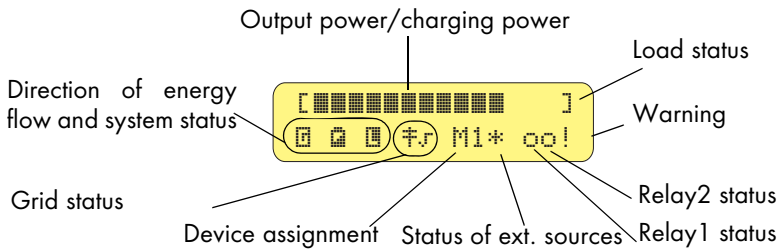





### 7.2 DC Circuit Breaker

The DC circuit breaker is used to switch on/off as well as disconnect the Sunny Backup 5000 on the DC side. For details, see section 9 "Activation and Deactivation" (Page 81).

## 7.3 Buttons

The table explains the button functions of the Sunny Backup 5000:

Button	Functions
	<ul style="list-style-type: none"> <li>– cancels the selected function</li> <li>– answers NO</li> <li>– navigates one menu level higher</li> </ul>
	<ul style="list-style-type: none"> <li>– navigates up one list element</li> <li>– increases data value</li> </ul>
	<ul style="list-style-type: none"> <li>– navigates down one list element</li> <li>– decreases data value</li> </ul>
	<ul style="list-style-type: none"> <li>– selects function</li> <li>– selects data value</li> <li>– confirms the change</li> <li>– answers YES</li> <li>– navigates one menu level lower</li> <li>– starts device (when held pressed down)</li> <li>– stops device (when held pressed down)</li> </ul>

## 7.4 Meaning of the Light-emitting Diodes (LEDs)

In the Sunny Backup 5000 control panel, there is both a green (above) and a red (below) light emitting diode (LED). Their functions are described in the table:

Green LED	Red LED	Operating mode
–	–	standby or off (no inverter operation)
ON	–	in operation
–	ON	failure or fault
ON	ON	initialization

## 7.5 MMC/SD Card

The Sunny Backup 5000 features an MMC/SD card which can be used for updating firmware and as a service interface. For details, please see section 11 "Archiving Data on an MMC/SD Card" (Page 101).



# 8 (First) Commissioning

## 8.1 Requirements

Before beginning with the commissioning, ensure that all electrical connections have the correct polarity and make sure that everything is connected according to the instructions in section 6 "Electrical Connection" (Page 39).



Always use the MMC/SD card to save data and events. This is necessary in order for SMA Technologie AG to be able to help you in the event of a fault.



The Quick Configuration Guide (QCG) allows you to quickly and easily commission your Sunny Backup 5000. To do so, use the menu to select the 'right' system for you. The display then shows a selection via which the parameters can be set specifically.

## 8.2 Starting the Quick Configuration Guide (QCG)

When starting the QCG, useful parameter values are set as default settings!



The QCG is automatically activated during the **initial** startup of the device.

1. Switch on the Sunny Backup 5000 by switching the DC circuit breaker to the "ON" position.
2. The Sunny Backup 5000 starts the startup phase. Wait for the following displays.

```
SIBFSBOOT V1.000
SMA SMA SMA SMA
SMA SMA SMA
SBU5000
@SMA 2007
```

When starting the Sunny Backup 5000 for the first time, the QCG is automatically activated. Please continue reading in point 6. Otherwise, follow this list.



3. As soon as the startup phase is finished, the message **To init system hold <Enter>** is displayed.
4. Press and hold down <Enter> until the Sunny Backup 5000 beeps three times.
5. You are now in the Quick Configuration Guide (QCG). Here you can select the following:
  - **"Start System"** (if you have accidentally accessed the QCG and only would like to restart the system)
  - **"New System"** (if you would like to start a new system or perform changes to the system configuration)
  - **"New Battery"** (if you would like to change the main battery settings, but retain the system configuration)
6. The following parameters must be set when **"New System"** is selected: (default setting shown in bold)
  - Country selection: 01# Country (GER VDE126-1-1, AUS AS4777)  
The country settings can be changed within the first 10 hours of operation. After this period a valid installer identification is required (see also section 10.7 "Entering the Installer Identification" (Page 98)).
  - Device type: 02# Device (**Master**, Slave 1, Slave 2)
  - System configuration: 03# Sys (**AS-Box-M**, AS-Box-L, AS-Box-XL)
  - Date: 07# Dt (dd.mm.yyyy)
  - Time: 08# Tm (hh:mm:ss)
  - Battery type: 09# BatTyp (**VRLA**, FLA, NiCd)
  - Nominal battery capacity: 11# BatCpyNom (100 Ah to 10000 Ah, default setting depends on the system configuration **140 Ah, 280 Ah, 280 Ah**)
  - External source: 12# ExtSrc (**Grid**, GenGrid)
  - Nominal generator current: 13# GnCurNom (0.0 A to 224.0 A, default setting depends on the system configuration **35 A, 44 A, 160 A**)
  - Generator start: 14# GnStrMod (**Autostart**, GenMan, Manual)
  - Nominal grid current: 15# GdCurNom (0.0 A to 224.0 A, default setting depends on the system configuration **35 A, 63 A, 160 A**)

The following parameters must be set when **"New Battery"** is selected:  
(default setting shown in bold)

- Battery type: 08# BatTyp (**VRLA**, FLA, NiCd)
- Nominal battery voltage: 09# BatVtgLst (42 V to **48 V**)
- Nominal battery capacity: 10# BatCpyNom (**100 Ah** to 10000 Ah)

If you have a system with more than one Sunny Backup 5000 device, you must first run the QCG on the slave(s) **before** starting the master device (display message "INIT MASTER OK START?"). Only the device type is set there. Only start the master device thereafter!



If the "New Battery" option is selected, only specific battery settings are reset and set to new values. System settings are not affected.



7. After entering the parameters listed below, the display of the master shows the following message:

INIT MASTER OK  
START?

8. Press <ENTER> to confirm. The following message then appears on the display.

STNDBY: To Start  
INU hold <ENTER>

9. Keep the <ENTER> button pressed. A beep is heard, the Sunny Backup 5000 starts and is operating.

If only one Sunny Backup 5000 is used in the system, the device type is set to "Master" and is not displayed.



If the device unexpectedly displays an error, it must be remedied before the device can be operated. For this purpose, refer to section 20 "Troubleshooting/ Problem Solving" (Page 159).



For more details on the adjustable parameters, please see section 19 "Parameter Lists" (Page 141).



Note that you must first enter the installer password before some parameters can be changed (see section 10.5 "Entering the Installer Password" (Page 94)). In addition, some parameters can only be changed in standby mode (see section 9.2 "Stopping" (Page 82)).





# 9 Activation and Deactivation

## 9.1 Activation / Startup

This step assumes that the Sunny Backup 5000 has been checked for

- correct (electrical) connections,
- voltages and polarities



and has already been put into operation by qualified personnel (qualified electrician).

1. Switch on the Sunny Backup 5000 by switching the DC circuit breaker to the "ON" position.
2. The Sunny Backup 5000 starts the startup phase. Wait for the following displays.

```
SIBFSBOOT V1.000
```

```
SMA SMA SMA SMA
SMA SMA SMA
```

```
SBU5000
@SMA 2007
```

As soon as the startup phase is finished, the message "To init system hold <Enter>" is displayed.

```
To init system
hold <Enter>
```

3. If you would like to access the QCG, press and hold <Enter> until the Sunny Backup 5000 beeps three times. Then the following display message appears (on how to proceed further, see section 8.2 "Starting the Quick Configuration Guide (QCG)" (Page 77)).
4. If you do **not** press <ENTER> within 5 seconds, the Sunny Backup 5000 skips the QCG and shows the following message.

```
01#StartMenu
New System
```

```
STNDBY:To Start
INV hold <ENTER>
```

Start the slaves **before** you start the master device.



- 5. After the device has been switched on, the slaves show the following message on the display.
 

STNDBY:To Start  
 INV hold <ENTER>
- 6. Hold <ENTER> pressed down and the remaining time is shown using bars on the display.
 

Hold to start...  
 ■■■■■■■■
- 7. Then the following message appears (until the master starts).
 

Ready  
 Wait for Master



Even with the "270.01 AutoStr" parameter set, the Sunny Backup 5000 must be manually started each time the device is switched on using the DC circuit breaker.

- 8. Press <ENTER> on the master device. A beep is heard, the Sunny Backup 5000 starts and is operating. The green (upper) LED is illuminated.



If the device unexpectedly displays an error, it must be remedied before the device can be operated. For this purpose, refer to section 20 "Troubleshooting/ Problem Solving" (Page 159).

## 9.2 Stopping

Proceed as follows to set the Sunny Backup 5000 to standby mode:

- 1. Press <ENTER> to stop the Sunny Backup 5000. The following message appears.
 

Hold to stop...  
 ■■■■■■■■■■■■
- 2. Hold <ENTER> pressed down and the remaining time is shown using bars on the display.
 

Hold to stop...  
 ■■■■■■■■
- 3. The Sunny Backup 5000 has been stopped and the display shows the following message:
 

STNDBY:To Start  
 INV hold <ENTER>



**Note that in standby mode there is still voltage present in the device (DC and AC1), and there may be a grid voltage through-connection.**

Even in standby mode, the Sunny Backup 5000 still requires about 4 W of power from the battery.



### 9.3 Deactivation

To switch off the Sunny Backup 5000, proceed as follows:

1. Set the Sunny Backup 5000 to standby mode (see section 9.2 "Stopping" (Page 82)).
2. Switch the DC circuit breaker of the Sunny Backup 5000 to the "OFF" position.

You can only ensure that all internal meter readings/values are saved by using this switching sequence.



You must wait at least 30 seconds before reactivating the device, otherwise proper operation of the Sunny Backup 5000 cannot be guaranteed.



### 9.4 Disconnecting the Device from Voltage Sources

1. Switch off the Sunny Backup 5000 (see section 9.3 "Deactivation" (Page 83)).
2. Disconnect the Sunny Backup 5000 from the battery.
3. Then disconnect the Sunny Backup 5000 from all voltage sources (switch off power for AC1 and disconnect it).
4. Make sure that the Sunny Backup 5000 has been disconnected from all voltage sources.
5. Wait at least five minutes to let the capacitors discharge and allow the voltage inside the device to drop to a safe level.
6. The Sunny Backup 5000 is now completely free of voltage and you can open it.

## 9.5 Reactivating the Device Following Automatic Shutdown



A complete shutdown indicates that components of the backup system or the Sunny Backup 5000 have failed or are not working correctly due to incorrect parameter settings. Check the backup system for possible faults, both before and after reactivating the system, to avoid a complete shutdown in the future.

To reactivate the Sunny Backup 5000 after it has switched off due to a battery being too deeply discharged, proceed as follows:

1. Switch off the DC circuit breaker.



**You must wait at least one minute to allow the capacitors to completely discharge before switching the DC circuit breaker on again.**

2. After waiting for one minute, switch on the Sunny Backup 5000 by switching the DC circuit breaker to the "ON" position.



If, in rare cases, the device cannot be switched back on, wait a little longer and try it again. This may result due to component tolerances.

3. Now, continue as described in 9.1 "Activation / Startup" (Page 81).



After reactivation, it is important that the batteries are charged. If the grid is available again, the grid will recharge the batteries after a few minutes.

4. Check that the Sunny Backup 5000 switches to charge mode.
5. Check that all other energy generators in your system are also working correctly.



If the Sunny Backup 5000 immediately switches to battery preservation mode after reactivation (see section 14.5 "Battery Preservation Mode" (Page 121)), check the availability of the grid, and the functionality of the Automatic Switch Box.

The loads can be reconnected once the Sunny Backup 5000 enters charge mode. A precondition for this is that a generator capable of providing the required power is connected, or that the grid is available.

## 10 Operation

The main menu consists of a Home Screen and the other main menu items where branches can be created in the sub menus. Operating modes are displayed on the Home Screen, e.g. the current operating mode, performance, etc. (see section 10.6 "Display Messages (Overview)" (Page 96)).

The menu consists of a main menu and maximum two submenu levels (see also the figure in section 10.1 "Menu Structure" (Page 87)).

Use the up and down arrow buttons to navigate through the menu levels. The cyclical arrangement (wrap around) allows you to scroll both forward and backwards to access the desired menu as quickly as possible.

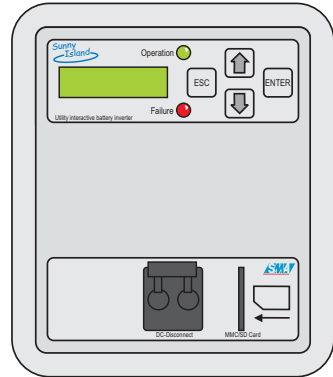

If you would like to access submenu 7, go backwards starting from 1 and continue past 9, instead of going six steps forwards.



Once you have reached the desired menu, press <ENTER> to access the menu. Use <ESC> to exit the menu and navigate one level higher.

You can skip menu entries. This takes place depending on the level of your password. It ensures that all parameters in the user level that may only be changed by the installer are skipped. The menu numbers are fixed, that means they do not change if an entry (or several entries) are skipped.



If you do not press any buttons for more than five minutes (inactivity), the Home Screen is automatically displayed.



After a brief period of inactivity, the background illumination of the display switches off. You can switch the background illumination back on by pressing one of the four buttons. No settings are changed when you press the button, this only activates the display illumination.



The beeping function is always activated by default. To deactivate it, set the "270.04 BeepEna" parameter to off.





Slave devices must wait for commands from the master devices. The following message appears during this time.

```
Ready  
Wait for Master
```

The Sunny Backup 5000 utilizes an operation concept referred to as "**Single Point of Operation**". For a system with more than one device, all entries are made on the master. There you configure the entire system, confirm events, warnings as well as errors in the QCG (see section 8 "(First) Commissioning" (Page 77)) and update your firmware when required (see section 11.6 "Firmware Update" (Page 106)).

**Exception:** When starting the device for the first time, you must set the slave in the QCG and everything else is performed at the master.



Single Point of Operation also means that all data, including the slave data, are saved at the master device on the MMC/SD card.



In multicluster operation, the operation concept „**Single Point of Operation**“ only ever applies within a cluster.



Messages can be displayed at any time while the device is in operation and they have priority over the Home Screen display.

## 10.1 Menu Structure

**Configuration and changes to system parameters may only be performed by qualified personnel (qualified electrician)**



The menu structure is divided into two levels:

- User level
- Installer level

The menus allowing system parameters to be changed can only be reached after entering the installer password (see section 10.5 "Entering the Installer Password" (Page 94)). These menu parameters can be used to monitor and control the Sunny Backup 5000 in normal daily operation.

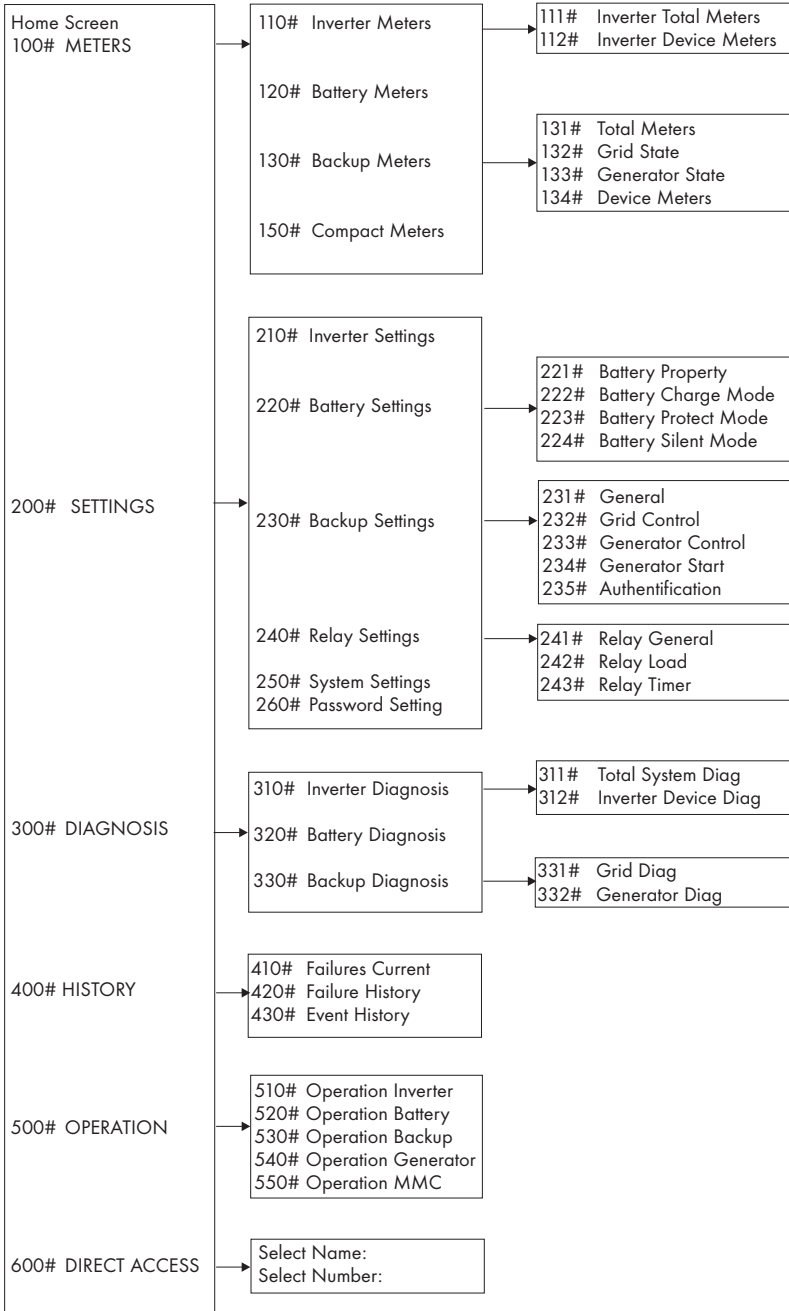



Furthermore, the menu structure is divided into five different main menus with corresponding submenus.

**Display values (Meters):** The "100# Meters" main menu displays the most important values in the first submenu:

- Sunny Backup 5000 ("110# Inverter Meters")
- Battery ("120# Battery Meters")
- Backup system ("130# Backup Meters")
- Compact messages ("150# Compact Meters")

There are additional submenus or individual parameters (e.g. "120.02 BatVtg" parameter) on the following second menu level.

**Settings:** Under the main menu "200# Settings" are several submenus allowing various system parameters to be viewed and changed:

- Sunny Backup 5000 ("210# Inverter Settings")
- Battery ("220# Battery Settings")
- Backup system ("230# Backup Settings")
- Relay ("240# Relay Settings")
- System ("250# System Settings")
- Password entry ("260# Password Setting")

**Diagnosis:** Under the main menu "300# Diagnosis" are several submenus allowing various system parameters to be viewed:

- Device data ("310# Inverter Diagnosis")
- Battery data ("320# Battery Diagnosis")
- Backup system data ("330# Backup Diagnosis")

**Lists (History):** Under the main menu "400# History" are several submenus allowing various lists to be viewed:

- Present failures ("410# Failures Current")
- Warnings and faults ("420# Failure History")
- Events ("430# Event History")

**Functions in operation:** Under the main menu "500# Operation" are several submenus allowing various system parameters to be viewed or changed:

- Inverter ("510# Operation Inverter")
- Battery ("520# Operation Battery")
- Backup ("530# Operation Backup")
- Generator ("540# Operation Generator")
- MMC/SD card ("550# Operation MMC")

**Direct Access:** Under the menu "600# Direct Access", you have direct access to settings and display values.

## 10.2 Changing Parameters

Using the up and down arrow buttons, you navigate through a selected menu (see figure in section 10.1 "Menu Structure" (Page 87)) to view or change a parameter, for example. When the relevant parameter appears on the display, you can read its present value.

An arrow  $\#$  next to the value indicates that the parameter can be changed.

If you press <ENTER>, the arrow begins to blink and you can change this parameter value using the up/down arrow buttons.



The increment (speed) of the change increases if you hold the button pressed down.

As soon as the desired value appears on the display, press <ENTER> to save the new value.

Then select Y(es) or N(o) by pressing the up/down arrow buttons to accept or reject the changes.

Afterwards, press <ENTER> again to end the operation and continue working.



Note that some parameters can only be changed when the device is in standby mode (see section 9.2 "Stopping" (Page 82)). You can find the parameters for which this applies in the tables in section 19.2 "Adjustable System Parameters" (Page 145) and 19.5 "Functions in Operation" (Page 156).

The Sunny Backup 5000 displays a corresponding message for parameters that can only be changed in standby mode or require a different password level.

### Display

### Meaning

No permission to change the value

Incorrect password level, you cannot make any changes in the menus. This is explained in section 10.5 "Entering the Installer Password" (Page 94).

Stop device to change the value

This parameter can only be changed in standby mode. Stop the Sunny Backup 5000 to change the parameter (see section 9.2 "Stopping" (Page 82)).

## 10.3 Direct Access

In the menu "600# Direct Access", you have direct access to selected parameters via the name, or to all parameters via the number.

Via the Select Name submenu, you have direct access to the following functions:

- ManChrgSel: manual initiation of an equalization charge (see section 14.4.3 "Equalization Charge" (Page 120))
- BkupTst: initiation of a backup system test (see section 18.7 "Sunny Backup System Test" (Page 140))
- GnManStr: manual activation of the generator (see section 15.2.1 "Manual Generator Operation" (Page 125))

Via the Select Number menu, you have direct access to every parameter by entering the parameter number.

Using the menu 600#, you can select the "222.01 BatChrgCurMax" parameter, for example, to set the maximum battery charging current.



The direct access must be entered as a five-digit number, for example, 24101. Here, the first 3 digits describe the menu number and the last two describe the parameter number.

Once the parameter has been set, you exit the setting. Using <ESC>, you return to Direct Access and you can make additional changes there.

## 10.4 Compact Meters

In this special menu, the Sunny Backup 5000 simultaneously displays a maximum of four values. This menu is primarily intended to facilitate the commissioning for the installer. There is a total of seven different compact meters.

You can select the different displays of the compact meters using the up/down arrow buttons. Here, you can also use the "Wrap Around" function.



The displays are always shown from the upper left to the lower right.

### Bat1 (battery values 1)

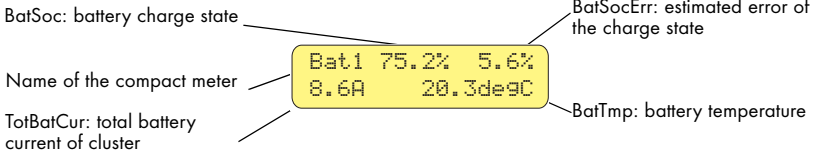

### Bat2 (battery values 2)

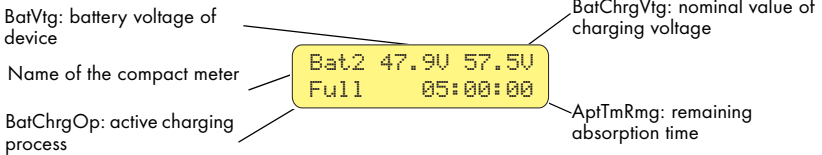

### Inv (AC values of inverter)

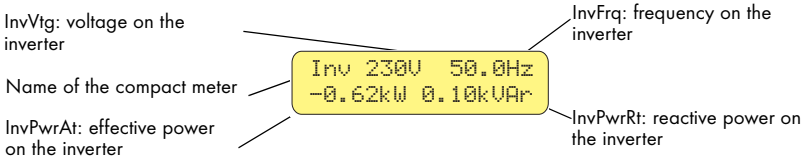

### InvTot (total AC values of inverter)

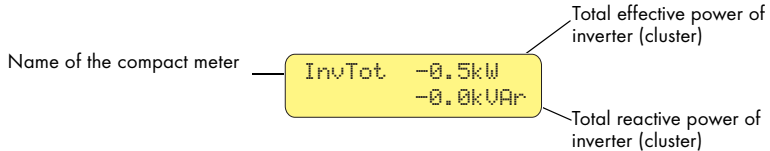

### Ext (backup AC values)

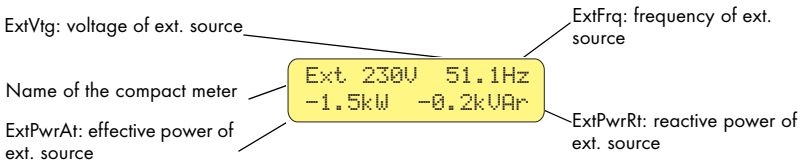

## ExtTot (total backup AC values)

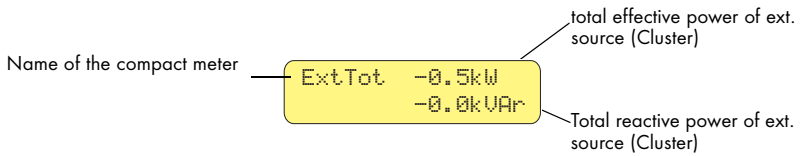

## OpStt (inverter and generator status)

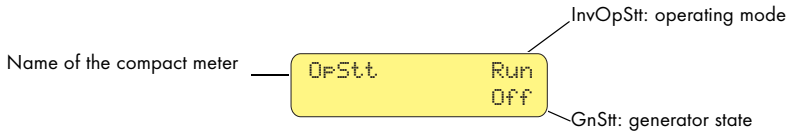

## 10.5 Entering the Installer Password



Sunny Backup 5000 parameter settings that affect the operating safety of the stand-alone grid system are protected/locked by the installer password.

These parameters may only be changed by qualified personnel (qualified electrician).



Do not provide the following information for entering the installer password to unauthorized persons. Illegal provision of this information to other persons will lead to invalidation of all SMA Technologie AG guaranty provisions.

The password required for access to all "Installer Level" parameters (see figure in section 10.1 "Menu Structure" (Page 87)) depends on the operating-hours counter (password = sum of the digits of the operating hours).

Proceed as follows to enter the installer password:

1. You are in the Home Screen. Keep pressing the down arrow button until you reach the menu "200# Settings". Press <ENTER>.
2. Now use the cyclic arrangement function (Wrap around) and press the arrow up button. Doing this opens the menu "260# Password Setting". Press <ENTER>.
3. You are now in the menu "260# Password Setting".
4. Press <ENTER>. You can now enter the password by pressing the up/down arrow buttons. The password is derived from the sum (of all digits) of the operating hours (OnTmh). In the example that would be  $1 + 2 + 3 + 4 + 5 + 6 = 21$ ).
5. Then press <ENTER> to confirm the password. You are now in the installer level [1].
6. Exit the menu by pressing <ESC>.

200# Settings

260 Password Setting

PW:\*\* Level[0]  
OnTmh 123456 h

PW:21 Level[0]  
OnTmh 123456 h

PW:21 Level[1]  
OnTmh 123456 h

If the password is not valid, the Sunny Backup 5000 does **not** switch into the installer level. In this case, recalculate and re-enter the installer password as described in this section.



The installer level is switched back to the user level if

- the Sunny Backup 5000 is switched off and on again (see section 9 "Activation and Deactivation" (Page 81)),
- specific parameters are entered (e.g. the "510.01 InvRs" parameter) that cause a restart,
- an incorrect password is entered and if
- no buttons are pressed for a period of 5 minutes.

## 10.6 Display Messages (Overview)

The display has two lines each with 16 characters. The first line displays the menu number and the menu name or where applicable, parameter name. The menu name is supplemented or the added text is displayed (e.g. parameter value) in the lower line, if required.

The following message is displayed in the Home Screen:

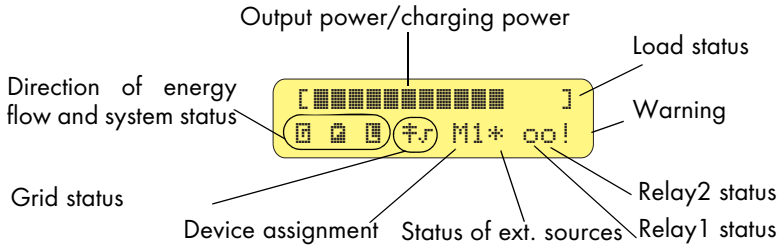

In the upper line, a bar graph displays the total output or charging power.

A character to the right of the graph indicates the load status: Here, "]" stands for nominal output. If the nominal load is exceeded, the character appears as ">".

The direction of energy flow and the system status are displayed on the left in the lower line. Here, the symbols stand for the generator side ("generator/grid"), for "battery" and for load side ("loads/Sunny Boys"). The arrows between the symbols indicate the direction of energy flow.

The symbol  $\neq$  represents a power pole. The symbol to the right of this indicates whether the grid parameter ( $\cdot$ ) or the offgrid parameter ( $\times$ ) is activ.

The device assignment follows (master or slave, e.g. M1 or S1).

Next to this assignment, the status of the external sources is indicated with the following symbol meanings:

- \* Generator voltage and frequency are within the set limits.
- ? Generator voltage and/or frequency are outside of the set limits. The Sunny Backup 5000 will not connect the generator to the stand-alone grid while this situation exists.
- ! The maximum permissible generator reverse power has been exceeded and the Sunny Backup 5000 disconnected the generator from the stand-alone grid.

The following letters indicate why the generator was requested:

- B**(attery) Generator has been requested as a result of the battery charge level.
- L**(oad) Generator has been requested as a result of the load-dependent generator request.



- S(start)** Generator has been requested by the operator manually setting the generator request in the Sunny Backup 5000 from "Auto" to "Start". The generator is then NO LONGER controlled or switched off automatically by the Sunny Backup 5000.
- T(ime)** Generator was started for 1 hour via the "Run1h" setting at the Sunny Backup 5000. Once this time has passed, the Sunny Backup 5000 automatically switches off the generator.

The generator status and the reason for the request are shown on the display alternatively under "status of external sources".



If, for example, the display changes every 3 seconds from "\*" to "B", this means that the generator voltage and frequency lie within the specified limits and that the generator was requested as a result of the battery charge level.



If the generator has been manually set to "Stop", then no generator status information is shown on the display. The field remains empty.



The messages for both relays (filled in circle = activated / open circle = deactivated) follows in the lower line.

The line ends with a warning display (!). This symbol blinks until you have viewed the warning in the menu "410# Failures Current" or "420# Failure History".

If faults occur, the device switches into standby mode and shows the fault on the display. The fault must be remedied and then confirmed. The Sunny Backup 5000 can be restarted thereafter.

In the Home Screen, the Sunny Backup 5000 also shows the following values in succession (in 3-second intervals: parameter name and parameter value) in the upper line:

- Bar graph for output power or charging power (the direction of energy flow is displayed by the arrows in the lower line)
- Total effective power of inverter (cluster)
- Effective power of external source (all phases)
- Present battery charge state (SOC)
- Counters (always one of five possibilities, depending on priority)
  - remaining absorption time
  - remaining generator warm up time
  - remaining generator time of Run1h
  - remaining time of Timer1

- remaining time of Timer2

- Active charging process

The display of the lower line remains as previously described.



Depending on the situation, the values that are shown alternatingly on the display are either shown or hidden. That means that if no generator is connected, no generator values appear on the display.



On the slave devices, only the bar graph is displayed for output power or charging power and in the lower line, the device assignment (e.g. S1 for slave 1) and where applicable, the status of external sources (\*, for a description, please see further above) are displayed.

## 10.7 Entering the Installer Identification



Some safety-related parameters regarding the SMA grid guard are specially protected, and cannot be altered with the normal installer password. In order to adjust these grid monitoring parameters, you must request your individual SMA grid guard password on the SMA Hotline.

To enter this into the Sunny Backup 5000, you must proceed as follows:

1. Use the arrow buttons to get to the menu **200# Settings**. Press <ENTER>.
2. Enter the installer password as described in section 10.5 "Entering the Installer Password" (Page 94).
3. Use the arrow buttons to get to the menu **"230# Backup Settings"**. Press <ENTER>.
4. Use the arrow buttons to get to the menu **235# Authentication**. Press <ENTER>.
5. Now enter the individual digits of the 10-digit code, using the arrow buttons. Each number in each position must be confirmed with the <ENTER> button, then the cursor automatically advances to the next position.
6. Once all the digits have been entered correctly, conclude the entry with the <ENTER> button. The device is now unlocked.
7. By pressing ESC, you return to the previous menu level, **230# Backup Settings**.

8. Now use the arrow buttons to get to the menu **232# Grid Control**. Confirm using the <ENTER> button.
9. Now select the grid monitoring parameters which are to be changed ("232.01 GdVtgMin", "232.02 GdVtgMax", "232.05 GdFrqMin", "232.06 GdFrqMax", " 232.40 Country") and adjust the values.

These parameters are safety-related grid monitoring parameters. To change the SMA grid guard parameters, you must enter your personal SMA grid guard password (Inst.-Code). Call the SMA Hotline to obtain your personal SMA grid guard password.



## 10.8 Parameter Display

Parameters on the Sunny Backup 5000 are displayed as follows:

In the upper line, the parameter number comes first, then a separator (hash) followed by the parameter name. In the lower line, there is the value with the unit and the modification mark (enter arrow) is on the far right.

**02#AptTmBoost**  
**120 min**

If you would like to switch from a menu (regardless of whether it is a main or submenu) into a parameter/value list, the menu numbers are not included on the display.



The syntax specified here for menus and parameters apply to the entire document. A menu is marked with a menu number, hash and menu name (130# Backup Meters).

A parameter is marked with a menu number, dot, parameter number and parameter name (131.01 TotExtPwrAt).



## 10.9 Display of Events

The Sunny Backup 5000 can display a list of events:

The serial number (quantity) of the events, the time and date display, which changes in 2-second intervals, is in the upper line. The event number is in the lower line.

**001 11:55:01**  
**E108 -----**

## 10.10 Display of Warnings and Errors

The Sunny Backup 5000 can display a list of warnings:

The serial number (quantity) of the errors, the time and date display, which changes in 2-second intervals, is in the upper line. The error number and name are in the lower line.

```
001 11:55:01 C  
F212 Warning
```

"!" on the right in the upper line indicates when the warning or the fault occurred.

"C" on the right in the upper line indicates when the warning or the error was confirmed or cleared.



As a shortcut, press ESC and the arrow up button simultaneously to go directly to the error list (420# Failure History).

## 11 Archiving Data on an MMC/SD Card

The Sunny Backup 5000 can save firmware, parameters and measuring data on a multimedia card (MMC/SD card) that must be FAT16-formatted and may have a maximum capacity of 2 GB (possible memory capacities are 32/64/128/256/512 MB as well as 1 GB and 2 GB). File names are saved in 8.3 format and files with other names are ignored.

A valid 8.3 format is, for example, "M1LOG.DAT".

8.3 is the "old" MS-DOS format with a file name that has max. 8 figures before and 3 figures after the dot.



**SMA Technologie AG** recommends using MMC/SD cards made by Transcend.

If you use a memory card from another manufacturer, check whether the card is FAT16-formatted. If necessary, format the card. Note that this causes any data already stored on the card to be lost.



If you have inserted the MMC/SD card in your card reader on your PC, you can (when using WINDOWS) search for the corresponding drive in Explorer. The following data are on this drive (here: E:):

Name	Größe	Typ	Geändert am
evthism.log	20 KB	Textdokument	06.06.2007 03:42
failism.log	20 KB	Textdokument	06.06.2007 03:42
si030607.evt	10 KB	EVT-Datei	03.06.2007 23:47
si030607.log	743 KB	Textdokument	03.06.2007 23:47
si040607.evt	10 KB	EVT-Datei	04.06.2007 03:53
si040607.log	743 KB	Textdokument	04.06.2007 03:53
si050607.evt	10 KB	EVT-Datei	05.06.2007 05:55
si050607.log	743 KB	Textdokument	05.06.2007 05:55
si060607.evt	10 KB	EVT-Datei	06.06.2007 03:41
si060607.log	743 KB	Textdokument	06.06.2007 03:41
sipar1.lst	30 KB	LST-Datei	30.05.2007 12:48
sipar2.lst	30 KB	LST-Datei	31.05.2007 22:56
update.bin	621 KB	BIN-Datei	05.06.2007 14:53

The files on the MMC/SD card have the following meanings:

File name	Meaning
evthism.log (evthisN.log for SlaveN)	event history of the device, saved by means of parameter "550.01 CardFunc", option StoEvtHis
failhism.log (failhisN.log for SlaveN)	failure history of the device, saved by means of parameter "550.01 CardFunc", option StoFailHis
si030607.evt	event/failure history for the day (format DDMMYY)
si030607.log	data archive for the day (format DDMMYY)
sipar1.lst	parameter list of the device, created by means of parameter "510.02 ParaSto", option Set1
sipar2.lst	parameter list of the device, created by means of parameter "510.02 ParaSto", option Set2
update.bin	software for the device



The "BOOTEX.LOG" file is not necessarily on the card. It is created depending on the operating system used (e.g. WindowsXP or Windows2000).

The firmware of the Sunny Backup 5000 expects device-specific data in the main directory of the MMC/SD card. This data includes a new firmware version, parameters and measuring data. The firmware ignores non-device-specific data in the main directory.

The Sunny Backup 5000 uses the MMC/SD card for saving and loading device parameters.

In addition, the Sunny Backup 5000 supports the acquisition and archiving of measuring data on the MMC/SD card. It saves this data in a special file. This contains, among other things, a header, time stamp, date and data type. There are three types of log data:

- Measuring data (are saved cyclically)
- Events and errors (are only saved when they occur)

The Sunny Backup 5000 supports the acquisition of measurement data with data from the following areas:

- Battery
- Inverter
- System
- External source
- Loads

Always use the MMC/SD card to save data and events. This is necessary in order for **SMA** Technologie AG to be able to help you in the event of a fault.



The data saved on the MMC/SD card can be processed using common table calculation programs.

The first 14 lines of the file are used for information (file header) and then two column heading lines follow. The following data is separated by a semicolon and decimals points are displayed by a dot. The date format is dd.mm.yyyy. The time format is hh:mm.

For additional information on processing the log data, please refer to the manual of the data processing software you use.



## 11.1 Inserting the Card

In order to avoid problems with electrostatic charge, you must ground yourself at the Sunny Backup 5000's housing before inserting or removing the MMC/SD card.



Insert the MMC/SD card into the card receptacle on the Sunny Backup 5000, with the sloping corner pointing downwards (see figure).

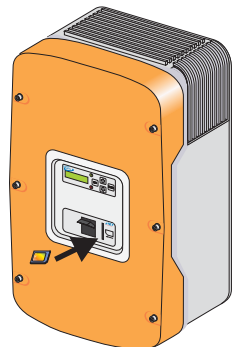

After inserting the MMC/SD card into the Sunny Backup 5000, a message appears on the display prohibiting the removal of the card:

```
Do not remove
MMC/SD card ...
```

The initialization of the MMC/SD card can take several minutes. During this time, the buttons are disabled and cannot be used for making entries. Three points appear in the lower line of the display.

If the operation was successful, the following is shown on the display:

```
MMC operatin
finished
```

In case of a fault, the following appears:

```
MMC operatin
failed
```

## 11.2 Removing the Card

To ensure that all log data is saved upon deactivation, write all as-yet unsaved data from the buffer to the MMC/SD card by using the parameter "550.01 CardFunc" with the option "ForceWrite".



If you remove the MMC/SD card without first activating the parameter "550.01 CardFunc", you lose up to a maximum of 15 minutes' data.

## 11.3 Saving and Loading Parameters

Using the "510.02 ParaSto" parameter, you can save the current parameter settings and using the "510.08 ParaLod" parameter, you can load the saved parameters.



Once the system is working optimally, it is a good idea to save these settings. This is especially useful if you try something new and then later wish to reset the inverter back to the previous settings.

You have the following selection options when saving the parameters:

- Set1 (save parameter set 1)
- Set2 (save parameter set 2)

You have the following selection options when loading the parameters:

- Set1 (load parameter set 1)
- Set2 (load parameter set 2)
- Factory (load the factory settings (reset))



The write protect function of SD cards (plastic sliding clip on the left side) is not supported by the Sunny Backup 5000. Please note this when writing data to your card.



## 11.4 Writing Log Data

Using the "550.02 DatLogEna" parameter, you can activate the function for writing log data to your MMC/SD card (activated by default).

If the Sunny Backup 5000 is writing data to the MMC/SD card, removing the card is prohibited and the following message appears on the display:

**Do not remove  
MMC/SD card ...**

## 11.5 Status Messages

Using the "312.07 CardStt" parameter, you can request the status of your MMC/SD card:

Display	Meaning
<b>Off</b>	Your MMC/SD card is deactivated.
<b>Operational</b>	Your MMC/SD card is activated.
<b>Out of Space</b>	The memory capacity of your MMC/SD card has been exceeded.
<b>Bad File Sys</b>	Your MMC/SD card has an invalid file format.
<b>INCOMP</b>	Your MMC/SD card is incompatible.
<b>Parameter</b>	Your Sunny Backup 5000 is loading parameters from the MMC/SD card.
<b>ParameterFailed</b>	Loading parameters from your MMC/SD card failed.



For help on troubleshooting, refer to section 20.9 "Troubleshooting" (Page 168)

## 11.6 Firmware Update

The firmware of the Sunny Backup 5000 can be updated using the MMC/SD card. When the Sunny Backup 5000 starts up or when the MMC/SD card is inserted, the Sunny Backup 5000 searches for special update files on the MMC/SD card. If it finds such files, it performs an update when the Sunny Backup 5000 is in standby mode.



Always save the latest firmware version on the MMC/SD card first; upon delivery this card is still empty (unwritten).

Set the master device to standby mode.

Insert the MMC/SD card into the master device.

While the master performs its update, the following message **Update 1/2** is shown on the display:



**Update 1/2**



**Update 2/2**



Once the update has been successfully completed, a mandatory reset follows so that the changes take effect.

After the reset, the master device remains in standby mode.

Activate it manually by holding down the <ENTER> button.

In a system with several Sunny Backup 5000 devices, the firmware is only updated on the master. If, during the subsequent startup from standby mode, the master detects that a slave has a different firmware version, it transfers its firmware to the slave and makes sure that all Sunny Backup 5000 devices within a system operate with the identical firmware version.



If a slave with a different firmware version is switched on, the master interrupts operation, performs a cluster update and starts up together with the slaves.

While the master updates the slave(s), the slave(s) display the same message as the master.

```
Update 1/2
```

```
Update 2/2
```

The following message appears on the master at the same time:

```
Updating Slaves
```

After the firmware update, the parameters are downloaded onto the slave devices.

Wait until all slave processes have terminated, and until the following display appears on the slave devices' screens:

```
Ready  
Wait for Master
```

Individual parameters and settings are retained during a firmware update.



## 12 Inverter Operation

### 12.1 Overload and Short-circuit Behavior

The Sunny Backup 5000 can be temporarily operated under overload conditions. It can also supply short-circuit currents.

In case of overload, the Sunny Backup 5000 supplies an output of 6500 W for 30 minutes and can supply 7200 W for 5 minutes. The device can even supply 8400 W of output power for one minute.

If a short circuit occurs, the Sunny Backup 5000 provides current of max. 100 A (for 100 ms). This is sufficient to trigger commercial 16 A B-type circuit breakers.

### 12.2 Device Faults and Autostart

If a critical fault occurs, the Sunny Backup 5000 automatically shuts down and displays the reason on the display. If the autostart function ("250.01 AutoStr" parameter) is activated, the Sunny Backup 5000 can automatically confirm any errors of category 2 or 3 (see section 20.7 "Error Categories" (Page 163)), and can restart on its own. If the fault remains, the Sunny Backup 5000 cannot be started.



If the autostart meter has counted down to 0, the Sunny Backup 5000 waits for 10 minutes before trying to automatically restart again.



Messages can be displayed at any time while the device is in operation and they have priority over the Home Screen display.

## 13 Grid

The Sunny Backup systems are designed as very rapidly switching backup power supplies for operation on the public grid. Here, a distinction is made between two main states:

- Public grid present
- Grid failure (stand-alone grid operation)

The operating mode of the inverter is derived from this. If the public grid is available, the loads in the main power grid are supplied with electricity, and the Sunny Backup 5000 charges the batteries, or keeps them fully charged. The PV system feeds into the public grid via a dedicated meter. Upon grid failure, the Sunny Backup system disconnects the public grid from the loads within no more than 20 ms, and supplies these loads with grid-quality voltage. While the grid remains down (stand-alone grid operation), the inverter is thus solely responsible for powering the loads. The PV system is then switched to the consumer side, and feeds a current into this stand-alone grid, depending on the solar radiation. If at any time more PV energy is being generated than consumed, it is stored temporarily in the battery. If more energy is being consumed than the PV system is generating, the extra energy required is taken from the battery.

### 13.1 Conditions

For operation on the public grid, the voltage and frequency threshold values as stipulated by the applicable local standard (for example in Germany the DIN VDE 0126-1-1 Standard) must be continuously monitored. If these thresholds are breached, the Sunny Backup system disconnects from the grid within no longer than 200 ms (value taken from the DIN VDE 0126-1-1).

During these 200 ms, the loads continue to be powered, as although the grid voltage or frequency breaches the thresholds, there is still sufficient voltage and frequency available. If the voltage fails completely, disconnection occurs in max. 20 ms.



In certain cases, it may be necessary to adapt the thresholds for voltage and frequency to the grid situation in order to prevent grid disconnection from occurring too frequently. In such instances, it is imperative to consult the energy supply company. To adjust these thresholds in the "232# Grid Control" menu, you must first enter your individual SMA grid guard password (see section 10.7 "Entering the Installer Identification" (Page 98)).



## 13.2 Operating on the Public Grid

In grid operation, the loads and the Sunny Backup 5000 are connected to the public grid. In this case, the voltage and frequency in both grids are identical. In grid operation, grid monitoring checks for breaches of the permissible limits for voltage and frequency (see Grid Reconnection), and for grid failure. If the thresholds are breached, or in the event of a complete grid failure, the public grid is disconnected, and operation continues almost uninterruptedly as a stand-alone grid. The battery is generally charged or its charge is maintained on the grid.

## 13.3 Grid Failure

A grid fault is characterized by the voltage or frequency being outside of the permissible limits (see section 13.5 "Grid Reconnection" (Page 110)) or the main power grid being disconnected. In this case, the time limits are relevant: Smaller deviations are permitted for longer than large deviations. In case of a grid fault/failure, the public grid is disconnected and the inverter starts, if it is not already running (silent mode).



If grid failure occurs while the Sunny Backup 5000 is in silent mode, this may cause a longer interruption period than that described in section 13.1 "Conditions" (Page 109).

## 13.4 Stand-Alone Grid Operation

If the public grid has failed, and the loads are disconnected, the inverter powers the stand-alone grid. The system waiting for the grid to reconnect is an indication of this state. As long as the battery has a sufficient charge level, the loads are powered. In stand-alone operation, charging may occur via the PV system, or other connected energy sources (CHP plants, wind energy systems, etc.).

## 13.5 Grid Reconnection

In stand-alone operation, the inverter constantly checks whether the grid has been reconnected (see above). If the voltage and frequency of the main power grid are within the permissible range of the "232.01 GdVtgMin" and "232.02 GdVtgMax" parameters for the "232.07 GdVldTm" time and the frequency is within the permissible range of the "232.05 GdFrqMin" and "232.06 GdFrqMax" parameters (see section 13.1 "Conditions" (Page 109)), the stand-alone grid is synchronized with the main power grid and then connected.

If the battery is fully charged, the frequency limits the power output of the AC feed-in generators (Sunny Boys) in the stand-alone grid. If the grid is now reconnected, the frequency would be lowered, if required, as the Sunny Backup 5000 is synchronized with the grid. The AC feed-in generators (Sunny Boys) would then feed additional energy into the system and possibly overload the batteries. In order to prevent this during such conditions, the stand-alone grid frequency is temporarily increased

("231.04 AcSrcFrqDel" parameter), in line with the synchronization, until the AC feed-in generators (Sunny Boys) are disconnected from the stand-alone grid as a result of the grid limits being exceeded.

The thresholds are cutoff limits; due to internal hysteresis, the reconnection limits are set somewhat more narrowly.



## 13.6 Limits and Power Adjustment

The Sunny Backup 5000 charges the public grid during each phase using the current specified via the "232.03 GdCurNom" parameter. The power that is not directly used by the loads flows into the battery for charging. The limits for the AC charging current limit ("210.02 InvChrgCurMax" parameter) on the Sunny Backup 5000 and the DC charging current limit ("222.01 BatChrgCurMax" parameter) are active at the same time. If the battery voltage reaches the charging voltage nominal value, it is also reduced (see section 14.4 "Charge Control" (Page 117)). If the current set using the "232.03 GdCurNom" parameter is not sufficient for powering the loads, the battery provides support.

## 13.7 Grid feeding from the battery



Before using the battery grid feed feature, please contact your energy supplier in order to verify the local standards.



This feature can only be used with the SBU-SET-M and SBU-SET-L.

The backup system can feed electricity from the battery into the public grid. This electricity is independent of the electricity from the PV system. The backup system measures the electricity fed on the grid side upstream of the grid/stand-alone grid contactor inside the Automatic Switch Box.

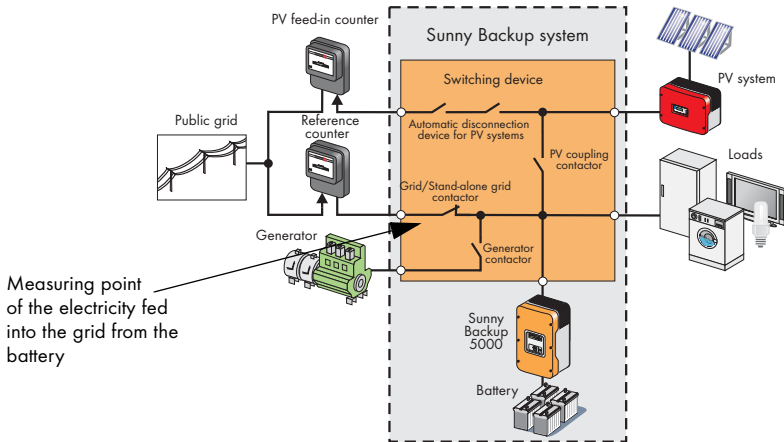

If the battery state of charge falls below a specific state of charge, the backup system discontinues the grid feeding ("232.43 FedInSocStp" parameter). If the battery state of charge increases again, the grid feeding is continued (parameter "232.42 FedInSocStr").



If, due to the low battery state of charge, the grid feeding is interrupted, the grid feeding period is ended as specified in the parameter settings. The battery is only charged by the grid after the set time has expired. This ensures that the public grid is not additionally compromised.



If energy-intensive loads are operated during the grid feeding, the inverter reduces the electricity to be fed. The respective nominal value for active current (parameter "232.46 FedInCurAt") or reactive current (parameter "232.47 FedInCurRt") is lowered until the nominal current does not exceed the value of 21.7 A.

Different grid feeding methods can be selected using the "232.41 FedInMod" parameter. A time-dependent or signal-controlled feeding can be selected.

### 13.7.1 Time-dependent grid feeding

If the "232.41 FedInMod" parameter is set to "Time", the electricity from the battery is fed into the public grid for a specified time period. The start time for the time-dependent grid feeding is set using the "232.44 FedInTmStr" parameter. The process is stopped using the "232.45 FedInTmStp" parameter setting. The active current to be fed into the grid is set using the "232.46 FedInCurAt" parameter and the reactive current is set using the "232.47 FedInCurRt" parameter.

### 13.7.2 Signal-controlled grid feeding

In this case, the grid feeding is activated by a external dry contact. For example by a ripple control signal which is sent from the energy supplier that has activated or ended the grid feeding. To allow this, set the "232.41 FedInMod" parameter to "Signal". The active current to be fed into the grid is set using the "232.46 FedInCurAt" parameter and the reactive current is set using the "232.47 FedInCurRt" parameter. Once the dry contact is closed, the Sunny Backup 5000 starts feeding the electricity into the public grid.

Connect the dry contact to the terminal strip „X7/Feed In Signal“ in the Automatic Switch Box.



## 14 Battery Management

The battery management of the Sunny Backup 5000 supports the following three battery types ("221.01 BatTyp" parameter):

- FLA** **Flooded Lead Acid**: closed lead acid batteries with liquid electrolyte in all standard designs available on the market (grid plate, tubular plate, small, large, etc.)
- VRLA** **Valve Regulated Lead Acid**: closed lead acid batteries with immobilized electrolyte in gel or AGM (**A**bsorbent **G**lass **M**at Separator) in all standard designs available on the market (grid plate, tubular plate, small, large, AGM, Gel, etc.)
- NiCd** **Nickel Cadmium**: pocket-type plate or fiber plate closed nickel cadmium batteries

The battery capacity ("221.02 NomBatCpy" parameter) is to be entered as the nominal capacity for a ten hour discharge (C10). If this is not available from the battery manufacturer's data sheet, it can be calculated from the data for different discharge times (120 h, 100 h, 20 h, 5 h, 1 h) in the following manner:

C10	C120/1.28	C10	C10
C10	C100/1.25	C10	C5/0.88
C10	C20/1.09	C10	C1/0.61

The Sunny Backup 5000 is designed and preset for a nominal battery voltage ("221.03 BatVtgNom" parameter) of 48 V (24 cells for every 2 V) with lead acid batteries (FLA and VRLA) and 45.6 V (38 cells for every 1.2 V) with nickel cadmium batteries.

If individual battery cells fail over several years of continuous operation, the nominal voltage can be set in the range from 42 V to 48 V. Up to three individual cells can be removed and the system can still be further operated.



This is not possible with 12 V blocks!

### 14.1 Battery Temperature

The Sunny Backup 5000 continuously monitors the battery temperature using the provided battery temperature sensor. A warning message is displayed once the battery temperature drops 5 °C below the maximum permissible temperature ("221.04 BatTmpMax" parameter).

When lead acid batteries drop -10 °C below the set limit and NiCd batteries drop -20 °C below the set limit, a warning is displayed.

The battery temperature is taken into consideration when the charging voltage is calculated (see section 14.4 "Charge Control" (Page 117)).



If the battery temperature sensor is not connected or a short circuit or a cable break on the sensor is detected, a warning message is generated; however, the Sunny Backup 5000 continues to operate at a fixed set battery temperature of 40 °C. Over time this leads to insufficient battery charging.

## 14.2 Start Options

If the battery or individual cells are removed from the battery bank in a system, the battery management must be restarted and configured. This can be done using the "Quick Configuration Guide QCG" (see section 8.2 "Starting the Quick Configuration Guide (QCG)" (Page 77)).

## 14.3 State of Charge/SOC and SOH

The Sunny Backup 5000 has a very precise internal charge level calculation (display value "120.01 BatSoc"). The operation for calculating the charge level is based on balancing the ampere hours. That means that all currents that flow in and out of the battery are added together and based on the nominal capacity. In order to take into consideration faults caused by self discharge and charging losses caused by gassing, these losses are already internally omitted. Unlike other operations, no fixed charging factor must be set.

When the fully charged state is reached, the charge state value is set back to 90 %, 95 % or 100 %, depending on how full the battery was actually charged. If the default settings are not changed, a charge state of 90 % is normally reached after a boost charge; a charge state of 95 % is normally reached after a full charge, and a charge state of 100 % is normally reached after an equalization charge.

Since fully charged states are only rarely achieved during a grid failure, the operation used here can also utilize the battery voltage during constant discharge phases with low discharge currents to recalibrate the charge state. These phases are generally reached at night. Compared to the ampere hour balancing method, the operation used here exhibits a high level of stability over the long term when recalibrated at regular intervals.

Both the ampere hour balancing method and the recalibration procedure, which is performed via the voltage, automatically adjust to the connected battery over time (depends on the number of grid failures). Since many of the battery types on the market today exhibit extremely varied behavior, no values can be determined. The best option is to make adjustments to the respective battery according to the procedures described above.

The estimated charge state error (display value "120.11 BatSocErr") will provide you with continuous information on the accuracy of the battery charge state currently calculated. The average error will continuously diminish as the adjustment to the actual battery increasingly improves.

Only when the battery is new does its usable capacity correspond to the capacity specified by the battery manufacturer. As the battery ages and as a result of frequent insufficient charging, the battery's useable capacity may decrease considerably on a permanent or only a temporary basis. The battery's state of health (display value "342.01 Soh") is a percentage measurement for the present useable capacity relative to the nominal capacity. 100 % means that the entire nominal capacity can still be utilized. At 50 %, only half of the original nominal battery capacity can be utilized. The battery's state of health is also calculated by means of a self-adapting method which however can only produce good and exact values after a number of grid failures, or after regular grid failures.

The present capacity for the Sunny Backup 5000 is automatically adjusted downwards for temperatures  $< 20^{\circ}\text{C}$ , since the useful capacity of batteries is significantly reduced in temperatures below the nominal temperature. For all lead acid batteries, the nominal capacity is amended by a fixed factor of  $-1\text{ \%/}^{\circ}\text{C}$ . For NiCd batteries a factor of  $-0.75\text{ \%/}^{\circ}\text{C}$  is used.

## 14.4 Charge Control

The Sunny Backup 5000 performs charge control in 3 phases, using the IUoU process. When the device operates with the public grid, there is also an optional fourth phase called silent mode.

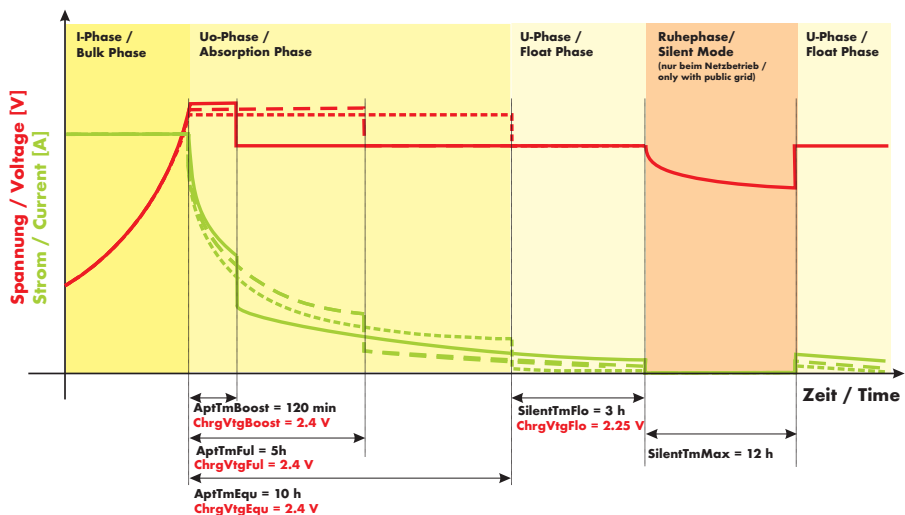

The I stands for the constant voltage phase (I phase). In this phase, the charging is limited by the maximum defined battery current ("222.01 BatChrgCurMax" parameter), the nominal generator current ("242.03 GnCurNom" parameter), the nominal grid current ("232.03 GdCurNom" parameter) or the maximum AC charging

current of the Sunny Backup 5000 ("210.02 InvChrgCurMax" parameter). The respective value reached first is the limiting value. During this phase the battery voltage increases as the battery is charged.

Once the battery voltage reaches the predefined value for the second phase  $U_0$  ("222.07 – 222.09", ChrgVtgBoost or ChrgVtgFul or ChrgVtgEqu parameters), the constant voltage charging (absorption phase) begins. In this phase, the battery voltage is maintained at a constant level, resulting in a continually decreasing battery current. The Sunny Backup 5000 remains in this phase for the defined period of time ("222.01 – 222.03", AptTmBoost or AptTmFul or AptTmEqu" parameters). For this charging phase, the Sunny Backup 5000 automatically selects one of the three possible charging processes (boost, full, equalizing) that are described in more depth between sections 14.4.1 and 14.4.3. The remaining charging time (display value "120.04 AptTmRmg") of this phase and the current process (display value "120.05 BatChrgOp") can be read on the display.

The following figure displays the relationship and the process diagram of the charging phases and charging processes.

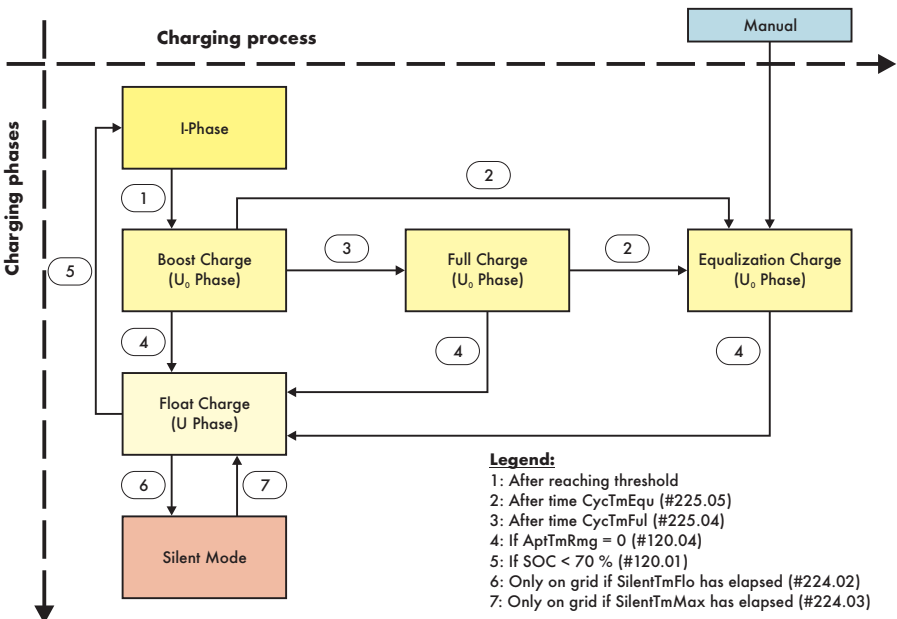

Once this constant voltage phase is finished, the Sunny Backup 5000 switches to float charge which again carries out constant voltage charging but at a greatly reduced charging voltage ("222.10 ChrgVtgFlo" parameter). The purpose of the float charge is

to keep the battery in a fully charged state without causing premature aging through overcharging. The Sunny Backup 5000 remains in this phase until either more than 30 % of the nominal capacity (all discharges are added together) has been used or the charge state is less than 70 %. When the Sunny Backup 5000 is operating on the public grid, it can also switch from the float charge into silent mode.

The charging voltage does not rapidly change, but is slowly adjusted to the new nominal value by approx. 0.5 mV/cell\*s as the constant voltage phase changes to the float charge. This also takes place if the nominal value is changed manually.



The charging capability of batteries is heavily dependent on the battery temperature. For temperatures <math><20\text{ }^\circ\text{C}</math>, the charging voltage must be slightly increased, and for temperatures >math>>20\text{ }^\circ\text{C}</math> it must be slightly decreased. This is necessary to prevent overcharging and insufficient charging reliably at any battery temperature. For this reason, the Sunny Backup 5000 is equipped with automatic temperature compensation of the charging voltage. The charging voltage is adjusted by 4 mV/°C and cell for battery types VLA and FRLA as well as by 0 mV/°C and cell with NiCd batteries. The temperature compensation value can be set using the "222.11 BatTmPCps" parameter.

If a Sunny Backup system is newly installed, the Sunny Backup 5000 first performs a full charge, then switches to float charge. Thus, the battery is always kept at a high charge level of 95 % to 100 %. Only after a grid failure during which the battery is discharged by more than 30 % is the battery recharged with one of the other charging processes (boost charge, full charge, or equalization charge).



### 14.4.1 Boost Charge

The boost charge enables the battery to be charged to approximately 85 % to 90 % by means of a high charging voltage for a short period.

Boost charges are primarily relevant if grid failures occur in relatively quick succession in order to then effectively recharge the battery as quickly as possible during the periods when the grid is available.



### 14.4.2 Full Charge

After a discharge of more than 30 %, the Sunny Backup 5000 automatically initiates a full charge if more than 14 days (parameter "222.05 CycTmFul") have passed since the previous grid failure. The objective is to recharge the battery to a charge level of at least 95 %.

### 14.4.3 Equalization Charge

After a discharge of more than 30 %, the Sunny Backup 5000 automatically initiates an equalization charge if more than 180 days (parameter "222.06 CycTmEqu") have passed since the previous grid failure. The objective is to recharge the battery to a charge level of at least 95 % to 100 %.

During this process, the Sunny Backup 5000 performs controlled overcharging of the battery bank to ensure that even the weaker cells are fully recharged. The equalization charge is simultaneously a type of battery maintenance, and extends the battery service life.

### 14.4.4 Silent Mode

Only during operation on the public grid, and at times when PV grid feeding is not possible, can the silent mode be used alongside the float charge. Silent mode causes the system's operating consumption to decrease significantly.

Silent mode is activated by means of the "224.01 SilentEna" parameter. The parameters "231.01 PvFeedTmStr" and "231.02 PvFeedTmStp" stipulate the times between which the PV system can feed; i.e. silent mode is possible in the remaining time window (PvFeedTmStp -> PvFeedTmStr).



During this period, the PV system is disconnected from the public grid, and cannot feed. Ensure that the only period stipulated here is one in which the PV system is also unable to generate energy (night).

The Sunny Backup system remains in silent mode for a fixed time ("224.03 SilentTmMax" parameter) or until the battery voltage per cell is 0.14 V lower than the set voltage ("222.10 ChrgVtgFlo" parameter). This ensures that the battery is always fully charged, even in silent mode.

If a grid failure is detected while in silent mode, the Sunny Backup 5000 restores power supply within approximately 30 ms. Thus, the interruption period is only slightly longer than during grid-parallel operation with float charge.

### 14.4.5 Manual Equalization Charge

An equalization charge can be manually triggered for the Sunny Backup 5000 at any time using the "520.01 ManChrgSel" parameter. The equalization charge is activated once the manual equalization charge has been confirmed. If the generator is connected to the system, it is automatically started and stopped again once the equalization charge has been completed.



An equalization charge should be performed at least once a year. Following a long period of time without charging, for example, with systems that are only operated seasonally, a manual equalization charge must always be performed at the end or beginning of the season.



## 14.5 Battery Preservation Mode

The Sunny Backup 5000 has a sophisticated battery preservation mode. The battery preservation mode prevents the battery from being deeply discharged, as much as possible, when the energy supply is low and thus prevents a total system failure as well as damage to the battery.

If a grid failure occurs, and significantly less energy is being generated by the PV system than is required, the battery will continue to discharge over time until it is virtually empty.



The battery preservation mode has three levels that are activated as a result of the state of charge (when the charge drops below the respective limit, "223.05 BatPro1Soc", "223.06 BatPro2Soc" and "223.07 BatPro3Soc" parameter):

**Level 1:** The first level is used to switch the inverter into standby mode in times during which the energy is not absolutely necessary (e.g. at night). You define the start time using the "223.01 BatPro1TmStr" parameter and define the stop time using the "223.02 BatPro1TmStp" parameter.

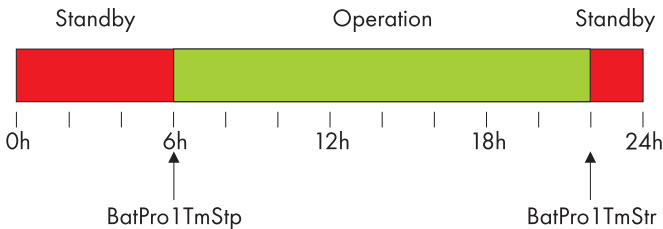

**Level 2:** The second level of the battery preservation mode ensures that the inverter regularly starts every two hours, but only during the window of time in which an energy supply is expected, and attempts to charge the battery from the AC side. For photovoltaic systems, this occurs during the day. In this case, you define the start time using the "223.03 BatPro2TmStr" parameter and the stop time using the "223.04 BatPro2TmStp" parameter.

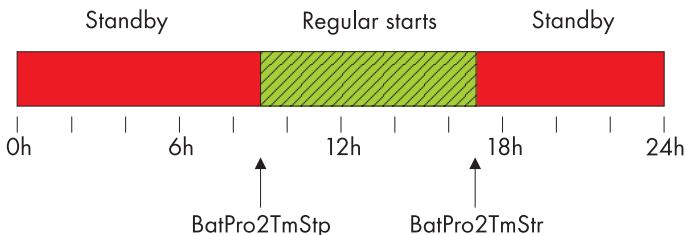

**Level 3:** The third level ensures that the battery is protected from deep discharge and thus protected against damage. In this case, the inverter is switched off completely. To start the inverter, see section 9.5 "Reactivating the Device Following Automatic Shutdown" (Page 84).

During all three levels, the inverter is only stopped if no battery current flows within 5 minutes (limit 3 A charging current).

The limits for all three levels can be set independently of one another. This allows individual levels to be skipped.



If the BatPro1Soc parameter < BatPro2Soc, level 1 is skipped and only level 2 is performed.

For level 1 and 2, a hysteresis of 5 % of the SOC charge level is designated for exiting this state.



**Battery preservation mode is not automatically exited if an external voltage source (grid reconnection) is present.**

The battery preservation mode on the Sunny Backup 5000 can be exited by manually starting the device. If, within 5 minutes (see above), charging current is detected, the Sunny Backup 5000 continues to operate; otherwise, it switches off again.

## 14.6 Battery Diagnostics

In the menu "320# Battery Diagnosis", many values are displayed that provide information on the past operational behavior of the battery. These values are helpful in checking the efficiency of the set parameters and in viewing the typical operating conditions of the battery (see section 19.3 "Diagnostics" (Page 154)).

## 15 Connecting a Generator

Sunny Backup systems support the integration of a generator (order option, cannot be retrofitted).

With Sunny Backup systems, the generator cannot be operated at the same time as the public grid, but rather instead of the public grid.

Thus, operation with combined heat and power (CHP) plants is not possible.



### 15.1 Generator Start

Depending on the battery charge state or the consumer power, the Sunny Backup 5000 can start a generator and of course stop it again as well. In this case, diverse limits and times are taken into consideration.

The Sunny Backup 5000 supports the following options for the generator start that can be adjusted using the "233.07 GnStrMod" parameter in standby mode:

- Manual
- Autostart
- GenMan

#### Manual (Manual Generator Start)

This setting is for generators that do not have an electrical remote starting option and, for example, are started using cable winches or cranks, among other things.

In this case, the Sunny Backup 5000 does not have the option of starting the generator. It only monitors the generator input. If, while monitoring the input, the device detects that the generator voltage and frequency are within the set limits (see 15.3 "Limits and Power Adjustment" (Page 128)), the device is synchronized and switches on following the warm up time.

The generator is also always switched off manually. The Sunny Backup 5000 then automatically switches into the operating mode without the generator.

The GnReq signal (see 16 "Relay" (Page 133)) is set for signaling the generator request and can thus be used as an alarm contact. If no request is pending, the signal is disabled again.

If an internal request is sent while the generator is already running, the signal is disabled until the generator is externally stopped and the stop time has expired.



A disconnecter should be located between the Sunny Backup 5000 and the generator. If the generator is to be stopped, it is first manually disconnected using the disconnecter and then it is stopped. This prevents powering the generator while switching it off.





**This integration of the generator requires permanent installation of the generator connection. Otherwise, if the generator connection at a plug socket is pulled out during operation, reverse voltage may arise at the plug for up to five seconds.**

## Autostart

This allows remote control generators to be directly integrated. They have a separate internal controller that controls the start procedure.

The Sunny Backup 5000 requests the generator using the GnReq signal. If the generator voltage and frequency are within the set limits (see 15.3 "Limits and Power Adjustment" (Page 128)), the device is synchronized and switched on following the warm up time.

The Sunny Backup 5000 keeps the request signal stable until a disconnection is made and the set power down time has expired.



Remote control generators can also have an internal power down cycle that is only activated when the request has been disabled. This can extend the power down time accordingly.



With some generator types, the voltage is only switched to the output after the internal warm up phase is finished. Therefore the time of the generator activation sequence is monitored internally:

Time to activation = 10 minutes for GenMan or  $2 \times "233.12 \text{ GnWarmTm}" + 2$  minutes for manual and autostart.

If you directly start the generator manually in this operating mode, the Sunny Backup 5000 detects the running generator and connects it once the warm up time has expired. If you stop the generator externally, this is detected and the generator is disconnected and the stand-alone grid continues to be powered.



If the generator is running after being externally started and a generator request occurs, the GnReq signal is disabled until the generator is externally stopped again and the stop time has expired.

## GenMan

If a GenMan (generator manager) (SMA order number: "SI-GenMan-...") is integrated into the system, it assumes direct control of the generator. It is connected between the Sunny Backup 5000 and the generator. The GenMan assumes control of the generator (warm up time, cooling off time and autostart).

Using the GnReq signal, the Sunny Backup 5000 requests the generator at the GenMan and keeps this signal stable until the request is successful. The GenMan returns the GENDY signal via DigIn (see 6.6 "GenMan Connection" (Page 62)) if the generator is ready for operation. Afterwards, the Sunny Backup 5000 can synchronize and connect. If the generator is no longer required, the Sunny Backup 5000 disconnects itself and disables the GnReq signal.

The GENDY signal sends a manual generator start at the GenMan to the Sunny Backup 5000. The device synchronizes and connects.

If the generator is externally and manually started at the GenMan, Sunny Backup 5000 blocks the GnReq signal:

- Manual stop and start are ignored on the Sunny Backup 5000 (operated using the display and keyboard).
- Internal requests (e.g. via the battery charge state) are also ignored.

If the generator has been manually started at the GenMan, it must also be stopped there.



The Sunny Backup 5000 disconnects the generator if the GenMan has disabled the GENDY signal.

A manual start directly at the generator is not permitted (see GenMan manual).



## 15.2 Generator Operation

The Sunny Backup 5000 allows automatic operation (depending on charge state or load) (see 15.2.2 "Automatic Generator Operation" (Page 126)). In addition, manual operation is also possible.

### 15.2.1 Manual Generator Operation

The manual operating modes for the generator management are triggered using the "540.01 GnManStr" parameter. Here a distinction is made between the following operating modes:

**Auto:** In this operating mode, the generator is automatically started due to the settings. This includes the start as a result of the charge state or the consumer power or by a request for a manual equalization charge ("520.01 ManChrgSel" = Start).

- Stop:** Manual generator stop if it is manually started. Cancels the present generator request – immediately disconnects from the generator and transitions into the lockout state. Once the lockout time has ended, the generator switches into automatic operation.
- Start:** Manual generator start – generator runs "continuously" until stop
- Run1h:** Operation for one hour. Once the lockout time has expired, the transition back into automatic mode follows.



**If the generator has been manually started (start), it must be manually stopped (stop).**

## 15.2.2 Automatic Generator Operation

In automatic operating mode ("234.01 GnAutoEna" parameter), the Sunny Backup 5000 automatically defines the settings (depending on battery charge state or load) as to when the generator starts and how long it runs. The automatic operating mode is activated using GnAutoEna = On (default). If GnAutoEna = Off, the automatic operating mode is deactivated.

In addition, the user can also manually start and stop the generator, if required.

### Charge State Dependent Start



**Manual specifications on the Sunny Backup 5000 take priority over the automatic operating mode. If the Sunny Backup 5000 is manually stopped while the automatic operating mode is activated, the Sunny Backup 5000 enters into stop/lock operating mode.**

**If the generator autostart is activated and all the conditions for automatic operation are satisfied, the Sunny Backup 5000 switches back into the start operating mode following the lockout time (or manual confirmation using the "540.02 GnAck" parameter).**

The time periods t1 and t2 are defined using the "234.07 GnTm1Str" and "234.08 GnTm2Str" parameters. The start time for t1 (and thus the end of t2) is defined using GnTm1Str, and the start time for t2 (end of t1) is defined using GnTm2Str.



If GnTm1Str = GnTm2Str, only settings for t1 are active!

The time intervals t1 and t2 are assigned charge states for start-up and stop using the "234.03 GnSocTm1Str", "234.04 GnSocTm1Stp", "234.05 GnSocTm2Str" and "234.06 GnSocTm2Stp" parameters. GnSocTm1Str designates the battery charge

state at which the generator is started during the  $t_1$  time and  $GnSocTm1Stp$  designates the charge state at which the generator is switched off during  $t_1$ . The  $GnSocTm2Str$  and  $GnSocTm2Stp$  parameters are similarly defined during the time  $t_2$ .

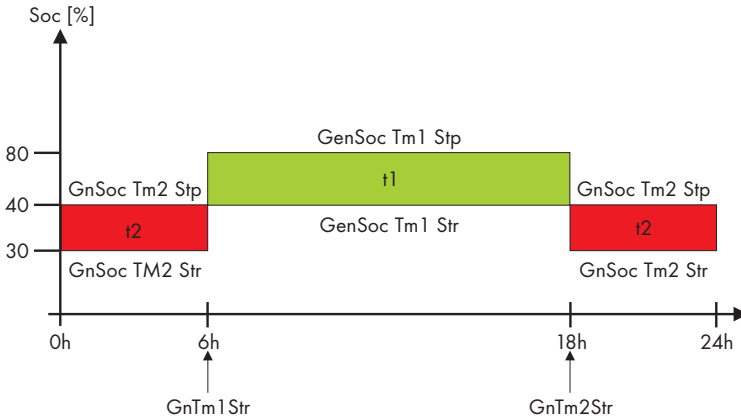

The figure displays an example of the settings if operation of the generator at night is to be avoided as much as possible. Between 6 a.m. and 10 p.m., the generator is started at a charge state (SOC) of 40 % and by contrast, the battery is discharged to 30 % at night (between 10 p.m. and 6 a.m.) before the diesel generator starts.



If the float charging process (see section 14.4 "Charge Control" (Page 117)) is activated before the cutoff limit ( $GnSocTm1Stp$  or  $GnSocTm2Stp$ ) is reached, the generator request is disabled again. If a full or equalization charge is active, the generator is only stopped after this charge is completed and not when "234.04  $GnSocTm1Stp$ " or "234.06  $GnSocTm2Stp$ " is reached.



## Load Dependent Start

In case increased energy demands arise, the generator can be requested for support. This function can be switched on or off (default) using the "234.09  $GnPwrEna$ " parameter. The function is only effective if the "234.01  $GnAutoEna$ " parameter is simultaneously set to On.

The load limit for the request and the generator stop is configured using the "234.10  $GnPwrStr$ " and "234.11  $GnPwrStp$ " parameters. The average time by which an average value for the consumer power is calculated can be set using "234.12  $GnPwrAvgTm$ ". This prevents temporary power consumption peaks that last for several seconds from causing a load dependent generator start.

If the generator has been started due to the load, it runs according to the minimum generator run time. If, once this time has expired, the average power is below the cutoff limit, the generator is stopped again.



Only the total consumer power of all phases is monitored. Individual phases in a multi-phase system are not monitored.

The consumer power is determined from the inverter power ("111.01 TotInvPwrAt") and generator power ("131.01 TotExtPwrAt").



Warm up times, minimum run times and power down times are also maintained for load dependent generator starts.

## 15.3 Limits and Power Adjustment

The voltage limits can be set using the "233.01 GnVtgMin" and "233.01 GnVtgMax" parameters and the frequency limits for generator operation can be set using the "233.05 GnFrqMin" and "233.06 GnFrqMax" parameters. If the values are outside these permitted limits, the generator is disconnected. Slightly restricted limits are applied to generator connection.

The voltage and frequency limits are monitored in phases. All phases on the master device must meet the defined limits to connect the generator.

The Sunny Backup 5000 charges the generator during each phase using the current specified in the "233.03 GnCurNom" parameter. The power that is not directly used by the loads flows into the battery for charging. The limits for the AC charging current limit ("210.02 InvChrgCurMax" parameter) on the Sunny Backup 5000 and the DC charging current limit ("222.01 BatChrgCurMax" parameter) are active at the same time. Low values for this limit may be the reason why the defined generator current cannot be adjusted. If the battery voltage reaches the charging voltage nominal value, it is also reduced (absorption phase, see section 14.4 "Charge Control" (Page 117)).



A sensible value for the "233.03 GnCurNom" parameter is approximately 80 % of the maximum generator current for each phase.

If the "233.15 GnCilMod" parameter is set to CurFrq, the generator is also limited at frequencies lower than the nominal frequency ("242.04 GnFrqNom" parameter). This function can be used if the full generator output is not always available and you want to prevent the generator from being overloaded. The default setting is only intended to control the nominal generator current.

If the current set using the "233.03 GnCurNom" parameter is not sufficient for powering the loads, the battery provides support ("real generator support").



## 15.4 Run Times

If the generator is started (or the Sunny Backup 5000 detects an external generator start), the warm up phase starts. If, during this time, the voltage or frequency detected is not within the permissible range, the warm up time begins again. If the generator cannot be connected at the GenMan within twice the time of "233.12 GnWarmTm" + 2 or 10 minutes, the connection process is cancelled and a new attempt is made. After three attempts, the system goes into error state (Fail). Once the 5-minute error wait time has expired, a new attempt is made.

If the generator has been connected, the minimum run time begins ("233.08 GnOpTmMin" parameter). The generator remains connected during this time, even if in the meantime the generator request is no longer pending.

If the minimum run time has expired and a request is no longer pending or the system detects that the set limits have not been maintained, the generator disconnects and transitions into the power down phase (Cool). If this power down phase is completed after the "233.10 GnCoolTm" time, the generator is stopped.

The power down time ("233.10 GnCoolTm" parameter) defined on the Sunny Backup 5000 should be set equal to or preferably greater than the power down time of the GenMan.



If a generator fault (e.g. generator failure) is detected, the generator is also disconnected and then stopped immediately. In doing so, the power down time is skipped.

Once the stop time ("233.09 GnStpTmMin" parameter) has expired, the generator is ready for the next request.

An internal generator request is disabled during the power down time and stop time or in error state.



If a generator fault is detected several times and the number of autostarts ("234.02 GnAutoStr" parameter) has been exceeded, the system transitions into the locked error state. This state lasts for the "233.11 GnErrStpTm" time. Once this time has expired, the generator is ready for another attempt.

The recording of autostarts is only reset after the generator has been successfully connected and the minimum run time has expired or when the locked error state (FailLock) is disabled.



The error state as well as the locked error state can be cancelled by confirming the generator fault ("540.02 GnAck" parameter).



The "133.03 GnRmgTm" process value is used to display the remaining time of the generator meter. Depending on the current request or the phase in which the generator state machine is, the following times are displayed:

- Remaining time of Run 1 h
- Remaining run time during the warm up time (Warm)
- Remaining minimum run time in operation (Run)
- Remaining run time during the power down time (Cool)
- Remaining stop time after the power down time has expired (Lock)
- Remaining time in the error state (Fail)
- Remaining time in the locked error state (FailLock)

## 15.5 Operation Together With Sunny Boys

If the battery is fully charged, the frequency limits the power output of the AC feed-in generators (Sunny Boys). If the generator is now manually started, for example, the frequency would be lowered, if required, as the Sunny Backup 5000 synchronizes with the generator. The AC feed-in generators (Sunny Boys) would then feed additional energy into the system and possibly overload the batteries. In order to prevent this during such conditions, the stand-alone grid frequency is temporarily increased ("231.04 AcSrcFrqDel" parameter), in line with the synchronization, until the AC feed-in generators (Sunny Boys) are disconnected from the stand-alone grid as a result of the grid limits being exceeded.

## 15.6 Stopping the Generator

If the Sunny Backup 5000 (automatically or manually) has started the generator, it can be manually stopped at any time using the "540.01 GnManStr" parameter. This disconnects the generator (the minimum run time is not taken into account here) and the power down time (Cool) is skipped. Afterwards, the system transitions into the stop time (Lock).



**If the generator start is performed directly at the GenMan or the generator, it can only be stopped there again. Triggering a stop here only disconnects the generator and the system transitions into the stop time (Lock).**



Generators with the manual start option can generally only be started and stopped at the generator.

If the generator start is to be disabled after a manual stop, this must be performed by setting the "234.01 GnAutoEnd" parameter to Off.



## 15.7 Stopping the Sunny Backup 5000

If the Sunny Backup 5000 is stopped by the user, the generator is immediately disconnected. The generator is then stopped (generator request, GnReq, is disabled). The power down phase (Cool) is skipped and the system transitions into the stop time.

**If the generator start is performed directly at the GenMan or the generator, it can only be stopped there again. Stopping the Sunny Backup 5000 here only disconnects the generator and the system transitions into the stop time (Lock).**



## 15.8 Failures

### Reverse Power

If the reverse power ("233.13 GnRvPwr" parameter) set for the "233.14 GnRvTm" time is exceeded, the generator is disconnected and stopped. The power down time (Cool) is skipped and the system transitions into the minimum stop time (Lock). After reverse power, connection is blocked for at least "231.02 ExtLkTm" or "233.09 GnStpTmMin".

### Generator Failure

If a generator failure is detected (failure on the master phase), the generator is disconnected immediately and a stop signal occurs on generator. Afterwards, the system transitions into the minimum stop time (Lock).



# 16 Relay

The Sunny Backup 5000 provides you with many options to control internal and external operations. For this purpose, two relays are integrated into the device with which you can assign functions using the "261.01 Rly1Op" and "261.02 Rly2Op" parameters. Information on the connection of both relays is provided in section 6.4.4 "Multi-function Relay 1 and 2" (Page 53). The different settings have the following meanings:

Function/ Settings	Meaning	Functional description
Off		relay remains permanently switched off (deactivated)
On		relay remains permanently switched on (e.g. relay function test during commissioning)
AutoGn	automatic generator request	the generator is automatically activated due to set criteria (see section 15.2.2 "Automatic Generator Operation" (Page 126)).
AutoLodExt	automatic load shedding dependent on an external source	automatic connection / disconnection of loads connection only occurs if the device is connected to an external source (e.g. generator), or if the absorption phase is active
AutoLodSoc1	Auto LoadShedding Soc1	automatic connection / disconnection of loads load is only connected if SOC limit 1 has exceeded the set value again
AutoLodSoc2	Auto LoadShedding Soc2	automatic load disconnection load is only connected if SOC limit 2 has exceeded the set value again
Tm1	timer 1 (time-controlled switching of relay 1)	programmable timer (once, daily, weekly) with duty cycle
Tm2	timer 2 (time-controlled switching of relay 2)	programmable timer (once, daily, weekly) with duty cycle
Apt+Phs	absorption phase active	relay is switched if battery charging is in the absorption phase
GnRn	generator active	relay is switched if generator is operating and connected.
ExtVfOk	external voltage and frequency is OK	external voltage and frequency are within the valid range for connection
GdOn	public grid	relay is switched if public grid is available and connected
Alm	alarm	Sunny Backup 5000 has a fault; in the case of a fault, contact is open (relay is deactivated)

Function/ Settings	Meaning	Functional description
Rn	run	Sunny Backup 5000 is in operation, contact is closed (relay is activated) if the device is running in inverter operation
BatFan	battery fan	relay is used for automatic battery room ventilation (switching the fan)
AcdCir	acid circulation	relay is used for automatic acid circulation (switching the electrolyte pump)



You can only assign one function to each relay.



The relays are changeover contacts. They have both a break contact as well as a NO contact.

Except for "Alm" (alarm), all relay functions are listed as NO contact functions, in other words, the contact is closed if the relay is activated by selecting the function. For the exception "Alm", the relay has a break function. This means that the relay is normally activated and opens the contact. It is only deactivated when a fault occurs and then closes the contact (and thus activates a warning light, for example).



In case of a fault, the relays go into the safe mode, that means they deactivate.

# 17 Sunny Boy

The following section provides information for configuring the Sunny Boy inverter in Sunny Backup systems. The Sunny Backup 5000 can be used in conjunction with all inverters from **SMA Technologie AG**.

## 17.1 Setting the Stand-alone Grid Parameters

As soon as you set the Sunny Boy to use stand-alone grid parameters, the device no longer meets the requirements of the applicable local standard for the connection of generators to the low-voltage grid (for example in Germany the DIN VDE 0126-1-1 Standard). In backup systems, this function is assumed by the Automatic Switch Box in combination with the Sunny Backup 5000.



Controlled battery charging is needed in a stand-alone grid. Sunny Boy inverters can reduce their feed-in power for this reason. This task is performed by a "Power adjustment via frequency" system (see section 17.2 "Frequency Shift Power Control (FSPC)" (Page 137)).

To activate this adjustment, you must configure the Sunny Boy as follows:

For changing the grid relevant parameters in the Sunny Boy inverter you need a special access code, the installer code. Contact the Sunny Island Hotline at the phone number +49 561 95 22 399 and by e-mail at SunnyIsland.Service@SMA.de to obtain this personal code.



To set the parameters, a communication channel to the Sunny Boy is required. Install one of these three variants:



- PC/laptop with Sunny Data software and a service cable for data transfer (SMA order number: "USBPBS-11" USB service interface)
- Sunny Boy Control
- Sunny WebBox

Additional information on communication can be found in section 6.5 "Interface for External Communication" (Page 58).

1. Establish a communication connection with the Sunny Boy.
2. Navigate to the parameter settings.
3. Set the "Default" parameter to "Offgrid" (stand-alone grid).

The "OffGrid" parameter setting automatically sets the following Sunny Boy parameters to the values below:

No.	Parameter	Short descr.	Value
1	I-NiTest	mA	Off (MSD = 0)
2	Uac-Min	V	180
3	Uac-Max	V	260
4	Fac-delta- lower range in which the Sunny Boy is active relative to $f_0$	Hz	-4.5 (starting from the base frequency $f_0$ )
5	Fac-max+ upper range in which the Sunny Boy is active relative to $f_0$	Hz	+4.5 (starting from the base frequency $f_0$ )
6	dFac-Max max. rate of change	Hz/s	4
7	Fac-start delta frequency increase in relation to $f_0$ , at which point the power adjustment via frequency begins	Hz	1 (starting from the base frequency $f_0$ )
8	Fac-Limit delta frequency increase in relation to $f_0$ , at which point the power adjustment via frequency ends. The output of the Sunny Boy at this point is 0 W.	Hz	2 (starting from the base frequency $f_0$ )

This completes the stand-alone grid parameter settings for the Sunny Boy.



**Never operate your Sunny Boy directly on the grid with these settings!**

**In the Sunny Backup system, only operate the Sunny Boys via the provided connection X4 / PV System in the Automatic Switch Box (see section 6.7.6 "PV System (X4/PV System)" (Page 69)).**



If Sunny Boy inverters are operated together with Sunny Backup 5000 devices on a communication bus, the "270.06 ComBaud" parameter in the Sunny Backup 5000 devices must be set to "1200" (default).

The Sunny Backup 5000 only communicates through the SMA-Net protocol, Sunny-Net is not supported.



It may happen that older SMA inverters cannot yet be set to "Offgrid" (stand-alone grid) via the "Default" parameter. In this case, the values 1 - 6 in the table must be set individually.



## 17.2 Frequency Shift Power Control (FSPC)

This section describes the operating principles of the "power adjustment via frequency" (Frequency Shift Power Control - FSPC).

This function is neither supported by the SMA PV inverters SB2100TL, SB3300TL, SB4200TL and SB5000TL, nor by older models in the SWR series. But these inverters can nevertheless be used in backup systems.



If the present battery voltage ( $V_{\text{Batt}}$ ) is higher than the nominal battery voltage ( $V_{\text{Batt nom}}$ ), the above-mentioned PV inverters are disconnected from the stand-alone grid present at that time, and are only reconnected after a battery discharge of at least 5 %.



If Sunny Boy inverters are connected to the AC side of a stand-alone grid, the Sunny Backup 5000 must be able to limit their output power. This situation can occur when (e.g.) the Sunny Backup 5000 battery is fully charged and the (solar) power available from the PV generator exceeds the power required by the connected loads.

To prevent the excess energy from overcharging the battery, the Sunny Backup 5000 recognizes this situation and changes the frequency at the AC output. This frequency adjustment is analyzed by the Sunny Boy. As soon as the grid frequency increases beyond the value specified by "Fac-Start delta" the Sunny Boy limits its output power accordingly.

This function is shown in the following figure:

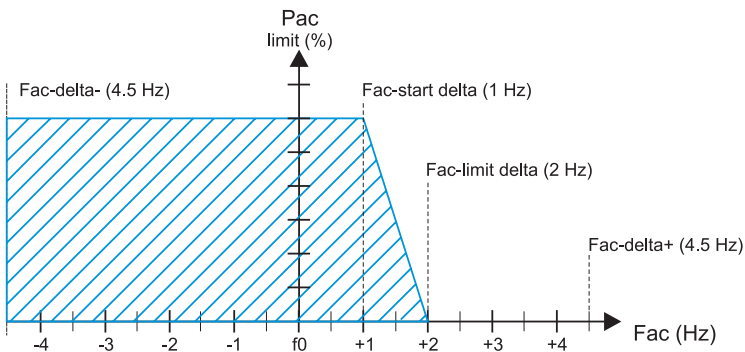

The points below have the following meanings:

- $f_0$  refers to the base frequency of the stand-alone grid.
- Fac-delta- and Fac-delta+ refer to the maximum range in which the Sunny Boy is active relative to  $f_0$ .
- Fac-start delta refers to the frequency increase relative to  $f_0$ , at which point the power adjustment via frequency begins.
- Fac-Limit delta refers to the frequency increase relative to  $f_0$ , at which point the power adjustment via frequency ends. The output of the Sunny Boy at this point is 0 W.

If the value is below the Fac-delta- limit or exceeds the Fac-delta+ limits, the Sunny Boys disconnect from the grid.

When FSPC is activated and the diesel generator in the stand-alone grid is operating, the diesel generator determines the frequency, and the Sunny Boys react to certain changes in the diesel generator frequency. The diesel generators generally operate at 50 Hz under load. For this reason, in most cases the Sunny Boys will deliver their entire power to the stand-alone grid, even when the generator is running.



If the current battery voltage ( $V_{\text{Bat}}$ ) is greater than the nominal battery voltage ( $V_{\text{Bat, nom}}$ ) and is also to be synchronized with an external source, the Sunny Backup 5000 temporarily increases the frequency and disconnects the Sunny Boys using the frequency shutdown method (overfrequency). Afterwards, it synchronizes with an external source.

## 18 Maintenance and Care

The Sunny Backup 5000 has been constructed for low maintenance. Thus, the necessary work is limited to only a few points.

### 18.1 Housing

Check that the Sunny Backup 5000 housing is mechanically sound. If damage (e.g. cracks, holes, missing covers) endangers the operating safety, the Sunny Backup 5000 must be deactivated immediately.

Larger particles of dirt should be removed from the device with a soft brush, or similar object. Dust can be removed with a damp cloth. Solvents, abrasives or corrosive materials must not be used for cleaning!

### 18.2 Cleaning the Fans

The cleaning intervals depend on the ambient conditions. If the fans are covered with loose dust, you can clean them with the aid of a vacuum cleaner (recommended) or a soft paint brush/hand brush. Clean the fans only when at a standstill. If it is necessary to replace the fans, please contact your installer.

### 18.3 Display

It is best to clean the control elements with a soft, damp cloth. Solvents, abrasives or corrosive materials must not be used for cleaning!

**Take care not to accidentally press the membrane buttons during cleaning. Only clean the membrane keypad when the device is deactivated.**



### 18.4 Functioning

Check regularly whether error messages are present. If an error message is displayed for which you cannot identify any apparent cause, the stand-alone grid must be inspected by an installer. To ensure optimal operation, the operator should regularly check the entries in the Sunny Backup 5000 error list at short intervals (monthly, or even weekly), especially during the first months after commissioning. This can help to discover hidden faults in the installation or errors in the configuration.

Once a year, visually inspect the ground connection at the house connection box, or on the meter board between PEN and the equipotential bonding bar!



## 18.5 Battery



A battery must be checked and maintained regularly. In this regard, observe the battery manufacturer's specifications.

## 18.6 Disposal

Dispose of the Sunny Backup 5000 at the end of its service life in accordance with the disposal regulations for electronic scrap which apply at the installation site at that time. Alternatively, send it back to **SMA Technologie AG** with shipping paid by sender, and labeled "FOR DISPOSAL" (see section 23 "Contact" (Page 183)).

## 18.7 Sunny Backup System Test

A functionality test of the Sunny Backup system should be conducted at least once a year with the function "530.02 BkupTst" which is implemented in the Sunny Backup 5000. With this function, you can activate backup operation even if the grid is available.

The Automatic Switch Box then disconnects the loads from the grid, and subsequently connects the PV system to the consumer grid. Thus, the loads are no longer powered by the public grid, but instead by your Sunny Backup system. You can also stop this test with the same function "530.02 BkupTst", and the system returns to grid-parallel operation.



Note that during the test, your PV system does not feed any power into the grid via the feed-in counter, and therefore earns no remuneration.

If possible, conduct the test when radiation is low.

If you do not manually stop the test, once the battery charge level reaches 40 %, the system automatically returns to grid-parallel operation, and recharges the battery. The reconnection to the electrical grid is carried out using the procedure described in section 13.5 "Grid Reconnection" (Page 110).

Thus, the Sunny Backup 5000, the Automatic Switch Box, and the battery are tested for correct functionality.

# 19 Parameter Lists

The following diagram provides an overview of the menu structure.

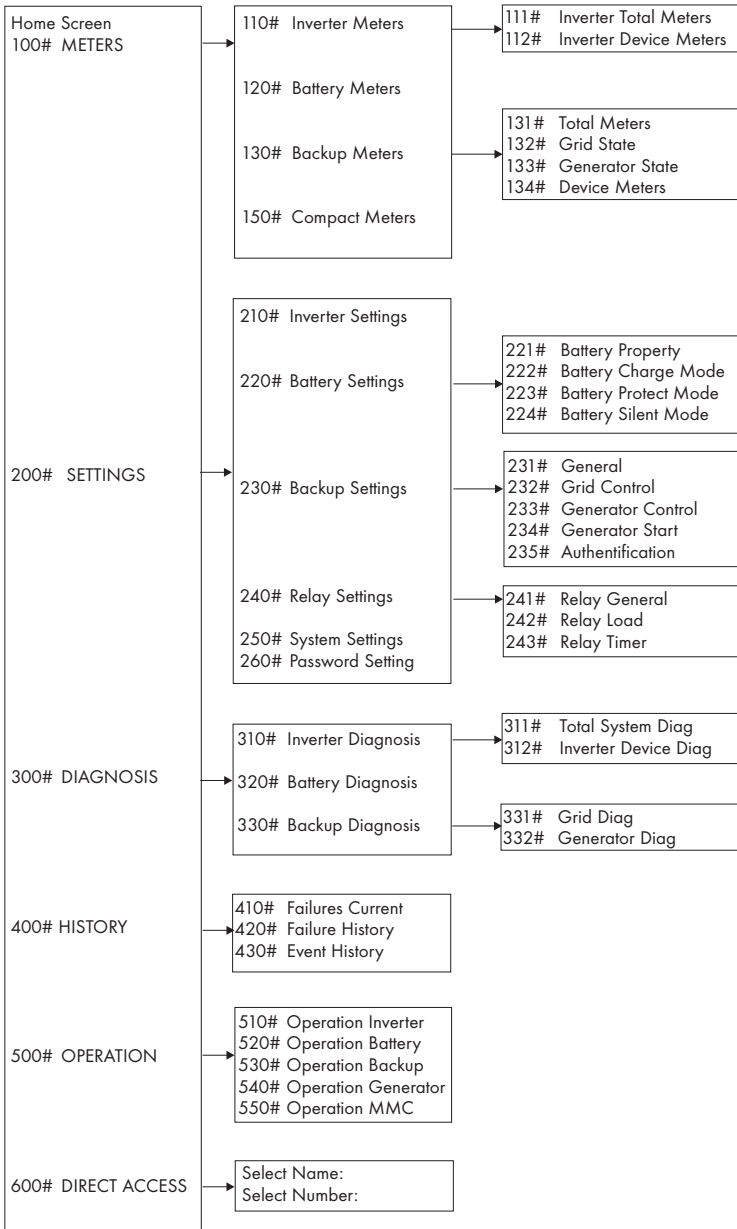

Only parameters in the menu branches "200-Settings" and "500-Operation" can be changed. All other values are only displayed in the Sunny Backup 5000 display. All menu items that can only be changed after entering the installer password are shaded in gray in the following tables.



Depending on the set system configuration, individual menu items may be missing. If you are only operating one Sunny Backup 5000 in your system, all menus that affect the slaves are omitted.



Be careful when setting parameters! Incorrect settings can lead to faulty operation of the inverter.  
Take note of the original values of all parameters that you change.



The current parameter settings can be saved onto the MMC/SD card using the "510.02 ParaSto" parameter. This is especially useful if you wish to try out new settings.



Once the system is working optimally, i.e. the selected settings have proven effective, then you can save the saved values on the MMC/SD card using the "510.02 ParaSto" parameter.

Afterwards, you can perform new settings. If you would like to reject these settings again, you can restore the system to its previous state using the "510.08 ParaLod" parameter.



The parameter names comply with the international standards IEC 61850-7-4 and 61400-25.

## 19.1 Display Values

### 110# Inverter Meters

Menu no.	Parameter no.	Parameter name	Range/ Short descr.	Description
<b>111# Inverter Total Meters</b>				
111	01	TotInvPwrAt	kW	total effective power of inverter (cluster)
111	02	TotInvCur	A	total inverter current (cluster)
111	03	TotInvPwrRt	kVAr	total reactive power of inverter (cluster)

Menu no.	Parameter no.	Parameter name	Range/Short descr.	Description
<b>112# Inverter Device Meters</b>				
112	01	InvOpStt	Standby Run EmCharge Error Startup KickOff	Operating mode: = standby = operation = emergency charge = error = transfer standby > operation = Sunny Boys are disconnected by frequency increase
112	02	InvPwrAt	kW	effective power at the inverter
112	03	InvVtg	V	voltage at the inverter
112	04	InvCur	A	inverter current
112	05	InvFrq	Hz	frequency at the inverter
112	06	InvPwrRt	kVA <sub>r</sub>	reactive power at the inverter
112	07	Rly1Stt	Off, On	state of relay 1
112	08	Rly2Stt	Off, On	state of relay 2

**120# Battery Meters**

Menu no.	Parameter no.	Parameter name	Range/Short descr.	Description
120	01	BatSoc	%	state of battery charge (SOC)
120	02	BatVtg	V	battery voltage
120	03	BatChrgVtg	V	nominal value of charging voltage
120	04	AptTmRmg	hhmmss	remaining absorption time (hhmmss)
120	05	BatChrgOp	Boost Full Equalize Float Silent	Active charging process: = boost charge = full charge = equalization charge = maintenance charge = silent mode
120	06	TotBatCur	A	total battery current of cluster
120	07	BatTmp	degC	battery temperature
120	08	RmgTmFul	d	time remaining until next full charge
120	09	RmgTmEqu	d	time remaining until next equalization charge
120	10	AptPhs	Off, On	absorption phase is active
120	11	BatSocErr	%	estimated error of the charge state

## 130# Backup Meters

Menu no.	Parameter no.	Parameter name	Range/Short descr.	Description
<b>131# Total Meters</b>				
131	01	TotExtPwrAt	kW	total effective power of external source
131	02	TotExtCur	A	total current of external source
131	03	TotExtPwrRt	kVAr	total reactive power of external source
<b>132# External Total</b>				
132	01	GdRmgTm	hhmmss	remaining time of GdValTm parameter (valid grid time) (hhmmss)
<b>133# Generator State</b>				
133	01	GnDmdSrc	None Bat Lod Tim Run1h Start ExtSrcReq	Source for generator request: = no request = battery charge state dependent = load dependent = time-controlled = for 1 hour = manually started = external source request
133	02	GnStt	Off Idle Warm Connect Run Retry Disconnect Cool Lock Fail FailLock	Generator state: = switched off = waiting for request (ready) = warming up = connecting = operation = restarting = disconnecting = cooling down = locked after operation = error = locked after error
133	03	GnRmgTm	hhmmss	remaining generator run time (minimum run time) (hhmmss)
133	04	GnRnStt	Off On	state of generator return signal on master (Dig-In)
<b>134# Device Meters</b>				
134	01	ExtPwrAt	kW	effective power of external source
134	02	ExtVtg	V	voltage of external source
134	03	ExtCur	A	current of external source
134	04	ExtFrq	Hz	frequency of external source
134	05	ExtPwrRt	kVAr	reactive power of external source

The "150# Compact Meters" menu is described in detail in section 10.4 "Compact Meters" (Page 91).



## 19.2 Adjustable System Parameters

Parameters marked with **(Stby)** are to be changed only when the Sunny Backup 5000 is in standby mode. Once the "ENTER" button is pressed, operating data values can immediately change to their new settings. Incorrect values in these parameters can probably not be corrected quickly enough to avoid potential damage to your system.



All menu items that can only be changed after entering the installer password are shaded in gray in the following tables.

All parameters can be set using a connected PC/laptop with the Sunny Data Control software, a Sunny WebBox or a Sunny Boy Control (see section 6.5 "Interface for External Communication" (Page 58)).

### 210# Inverter Settings

Menu no.	Parameter no.	Parameter name	Range/ Short descr.	Value	Description
210	02	InvChrgCurMax	A	20	maximum device charging current

### 220# Battery Settings

Menu no.	Parameter no.	Parameter name	Range/ Short descr.	Default value	Description
<b>221# Battery Property</b>					
221	01	BatTyp	VRLA FLA NiCd	VRLA	Battery type: = valve regulated lead acid = flooded lead acid = nickel cadmium can only be changed in QCG
221	02	BatCpyNom	Ah	100	nominal battery capacity (C10) can only be changed in QCG
221	03	BatVtgNom	V	48	Nominal battery voltage: 48 = VRLA 48 = FLA 45.6 = NiCd can only be changed in QCG
221	04	BatTmpMax	degC	40	maximum battery temperature
221	05	BatTmpStr	degC	35	battery restart temperature following stop due to overtemperature
221	06	ChrgCtlOp	Auto NoFrq SMA	Auto	DC charger type = automatic = no frequency shift control of AC sources = like Auto, plus SMA-compliant DC chargers (e.g. CC40)

Menu no.	Parameter no.	Parameter name	Range/ Short descr.	Default value	Description
<b>222# Battery Charge Mode</b>					
222	01	BatChrgCurMax	A	1200	battery charging current limit (depends on nominal battery capacity), 60 % of the nominal battery capacity (#221.02)
222	02	ApiTmBoost	min	120	Boost charge absorption time: 120 = VRLA 90 = FLA 300 = NiCd depending on the setting in QCG
222	03	ApiTmFul	h	5	Absorption time for full charge: 5 = VRLA 5 = FLA 7 = NiCd depending on the setting in QCG
222	04	ApiTmEqu	h	10	Absorption time for equalization charge: 10 = VRLA 10 = FLA 10 = NiCd depending on the setting in QCG
222	05	CycTmFul	d	14	full charge cycle time
222	06	CycTmEqu	d	180	equalization charge cycle time
222	07	ChrgVtgBoost	V	2.4	Cell voltage nominal value for boost charge: 2.4 = VRLA 2.55 = FLA 1.65 = NiCd depending on the setting in QCG
222	08	ChrgVtgFul	V	2.4	Cell voltage nominal value for full charge: 2.4 = VRLA 2.5 = FLA 1.65 = NiCd depending on the setting in QCG
222	09	ChrgVtgEqu	V	2.4	Cell voltage nominal value for equalization charge: 2.4 = VRLA 2.5 = FLA 1.65 = NiCd depending on the setting in QCG
222	10	ChrgVtgFlo	V	2.25	Cell voltage nominal value for float charge: 2.25 = VRLA 2.25 = FLA 1.55 = NiCd depending on the setting in QCG

Menu no.	Parameter no.	Parameter name	Range/Short descr.	Default value	Description
222	11	BatTmpCps	mV/degC	4.0	battery temperature compensation Absorption time for full charge: 4.0 = VRLA 4.0 = FLA 0.0 = NiCd depending on the setting in QCG
222	12	AutoEquChrgEna	Disable Enable	Enable	activates automatic equalization charge
<b>#223# Battery Protect Mode</b>					
223	01	BatPro1TmStr	hhmmss	220000	time for starting battery preservation mode level 1
223	02	BatPro1TmStp	hhmmss	060000	time for stopping battery preservation mode level 1
223	03	BatPro2TmStr	hhmmss	170000	time for starting battery preservation mode level 2
223	04	BatPro2TmStp	hhmmss	090000	time for stopping battery preservation mode level 2
223	05	BatPro1Soc	%	20	SOC limit for preservation mode level 1
223	06	BatPro2Soc	%	10	SOC limit for preservation mode level 2
223	07	BatPro3Soc	%	0	SOC limit for preservation mode level 3
<b>#224# Battery Silent Mode</b>					
224	01	SilentEna	Disable Enable	Disable	allows silent mode on the grid
224	02	SileniTmFlo (Stby)	h	3	max. time for float charge until transfer into silent
224	03	SileniTmMax (Stby)	h	12	max. time for silent mode until transfer into float
<b>#225 Battery Current Sensor</b>					
#225	01	BatCurSnsTyp	None 60mV 50mV	None	Stromsensortyp
#225	02	BatCurGain60	A/60mV	100	Externer Batteriestromsensor 60 mV-Typ
#225	03	BatCurGain50	A/50mV	100	Externer Batteriestromsensor 50 mV-Typ
#225	04	BatCurAutoCal	Start		Autokalibrierung des externen Batteriestromsensors

## 230# Backup Settings

Menu no.	Parameter no.	Parameter name	Range/Short descr.	Default value	Description
<b>231# General</b>					
231	01	PvFeedTmStr	hhmmss	040000	start time for PV grid feeding
231	02	PvFeedTmStp	hhmmss	220000	stop time for PV grid feeding
231	03	ExtLkTm	min	20	lock time after reverse power or relay protection
231	04	AcSrcFrqDel	Hz	4.8	frequency increase for disconnecting AC feed-in generators
231	09	ExtSrc	PvOnly Gen Grid GenGrid	Grid	Generator and grid operating mode: = PV only = grid = ext. sources = grid and ext. sources
231	13	PvInst	Disable Enable	Enable	PV installed
231	14	TotPvPwr	kW		total installed PV power
231	15	ClstPwrNom	kW	5	nominal cluster power output
<b>232# Grid Control</b>					
232	01	GdVtgMin *	V	187	minimum grid voltage
232	02	GdVtgMax *	V	261.5	maximum grid voltage
232	03	GdCurNom	A	16	nominal grid current
232	04	GdFrqNom	Hz	50	nominal grid frequency
232	05	GdFrqMin *	Hz	47.65	minimum grid frequency
232	06	GdFrqMax *	Hz	50.15	maximum grid frequency
232	07	GdVldTm	sec	30	minimum time required for grid (voltage and frequency) to be within permissible range for connection
232	08	GdMod	GridCharge GridFeed	GridCharge	grid interface
232	09	GdRvPwr	W	100	permissible grid reverse power (effective power)
232	10	GdRvTm	sec	5	permissible time for grid reverse power
232	18	GdVtgIncProEna	Disable Enable	Enable	allows voltage rise protection
232	19	GdVtgIncPro	V	253	threshold for voltage rise protection

Menu no.	Parameter no.	Parameter name	Range/ Short descr.	Default value	Description
232	40	Country	GER_VDE 0126_1_1; AUS_AS47 77	GER_VDE 0126_1_1	country selection
232	41	FedInMod	Off Time Signal Com	Off	Feeding of energy depending on time, digital signal or communication (This function is intended for future applications.)
232	42	FedInSocStr	%	40	Minimal SOC where feeding is started
232	43	FedInSocStp	%	20	Minimal SOC where feeding is stopped
232	44	FedInTmStr	hhmmss	0	Start time dependent grid feeding
232	45	FedInTmStp	hhmmss	0	Stop time dependent grid feeding
232	46	FedInCurAt	A	16	Active feeding current per phase
232	47	FedInCurRt	A	0	Reactive feeding current per phase
<b>233# Generator Control</b>					
233	01	GnVtgMin	V	172.5	minimum generator voltage
233	02	GnVtgMax	V	250	maximum generator voltage
233	03	GnCurNom	A	16	nominal generator current
233	04	GnFrqNom	Hz	50	nominal generator frequency (at nominal load)
233	05	GnFrqMin	Hz	44.64	minimum generator frequency
233	06	GnFrqMax	Hz	60	maximum generator frequency
233	07	GnStrMod	Manual Autostart GenMan	Autostart	generator interface
233	08	GnOpTmMin	min	15	minimum generator run time
233	09	GnStpTmMin	min	15	minimum generator stop time
233	10	GnCoolTm	min	5	generator cooling-off time
233	11	GnErrStpTm	h	1	generator stop time for generator fault
233	12	GnWarmTm	sec	60	warm up time (minimum time required for generator voltage and frequency to be within permissible range for connection)
233	13	GnRvPwr	W	100	permissible generator reverse power (effective power)
233	14	GnRvTm	sec	30	permissible time for reverse power/reverse current

Menu no.	Parameter no.	Parameter name	Range/ Short descr.	Default value	Description
233	15	ExtCtlMod	Cur CurFrq	Cur	ext. (gen/grid) controller (current or frequency)
<b>234# Generator Start</b>					
234	01	GnAutoEna	Off On	On	activate generator autostart
234	02	GnAutoStr		3	number of autostarts
234	03	GnSocTm1Str	%	40	SOC limit for switching on generator for time 1
234	04	GnSocTm1Stp	%	80	SOC limit for switching off generator for time 1
234	05	GnSocTm2Str	%	40	SOC limit for switching on generator for time 2
234	06	GnSocTm2Stp	%	80	SOC limit for switching off generator for time 2
234	07	GnTm1Str	hhmmss	0	time 1 for generator request (begin time 1, end time 2) (hhmmss)
234	08	GnTm2Str	hhmmss	0	time 2 for generator request (begin time 2, end time 1) (hhmmss)
234	09	GnPwrEna	Off On	Off	activate generator request as a result of power
234	10	GnPwrStr	kW	4	activates generator as a result of power limit
234	11	GnPwrStp	kW	2	deactivates generator as a result of power limit
234	12	GnPwrAvgTm	sec	60	average time for power-related generator start



Parameters designated with \* are safety-related grid monitoring parameters. To change the SMA grid guard parameters, you must enter your personal SMA grid guard password (Inst.-Code). Call the SMA Hotline to obtain your personal SMA grid guard password.

## 240# Relay Settings

Menu no.	Parameter no.	Parameter name	Range/ Short descr.	Default value	Description
<b>241# Relay General</b>					
241	01	Rly1Op	Off On AutoGn AutoLodExt  AutoLod1Soc AutoLod2Soc  Tmr1 Tmr2 AptPhs GnRn ExtVfOk  GdOn Error Warm Run Ens1 Ens2 BatFan AcdCir	AutoGn	Function of relay 1: = switched off = switched on = automatic generator connection = automatic load disconnection, only activated if external sources are present = automatic connection / disconnection of loads due to SOC1 = automatic connection / disconnection of loads due to SOC2 = programmable timer 1 = programmable timer 1 = absorption phase is active = generator is running = ext. voltage and frequency in permissible range = ext. grid is connected = error = warmup = operation (= currently has no function) (= currently has no function) = battery room fan = electrolyte pump
241	02	Rly2Op	see 261.01	AutoLodExt	Function of relay 2: for details, see 241.01
<b>242# Relay Load</b>					
242	01	Lod1SocTm1Str	%	30	SOC limit for load shedding 1 start for t1
242	02	Lod1SocTm1Stp	%	50	SOC limit for load shedding 1 stop for t1
242	03	Lod1SocTm2Str	%	30	SOC limit for load shedding 1 start for t2
242	04	Lod1SocTm2Stp	%	50	SOC limit for load shedding 1 stop for t2
242	05	Lod1Tm1Str	hhmmss	0	load shedding 1 time 1 (begin time 1, end time 2)
242	06	Lod1Tm2Str	hhmmss	0	load shedding 1 time 2 (begin time 2, end time 1)
242	07	Lod2SocTm1Str	%	30	SOC limit for load shedding 2 start for t1
242	08	Lod2SocTm1Stp	%	50	SOC limit for load shedding 2 stop for t1

Menu no.	Parameter no.	Parameter name	Range/Short descr.	Default value	Description
242	09	Lod2SocTm2Str	%	30	SOC limit for load shedding 2 start for t2
242	10	Lod2SocTm2Stp	%	50	SOC limit for load shedding 2 stop for t2
242	11	Lod2Tm1Str	hhmmss	0	load shedding 2 time 1 (begin time 1, end time 2)
242	12	Lod2Tm2Str	hhmmss	0	load shedding 2 time 2 (begin time 2, end time 1)
<b>243# Relay Timer</b>					
243	01	RlyTmr1StrDt	yyyymmdd	20060101	start date timer 1
243	02	RlyTmr1StrTm	hhmmss	0	start time for relay control timer 1 (hhmmss)
243	03	RlyTmr1Dur	hhmmss	0	run time for relay control timer 1 (hhmmss)
243	04	RlyTmr1Cyc	Single Daily Weekly	Single	repeated cycle time for timer 1
243	05	RlyTmr2StrDt	yyyymmdd	20060101	start date timer 2
243	06	RlyTmr2StrTm	hhmmss	0	start time for relay control timer 2 (hhmmss)
243	07	RlyTmr2Dur	hhmmss	0	run time for relay control timer 2 (hhmmss)
243	08	RlyTmr2Cyc	Single Daily Weekly	Single	repeated cycle time for relay 2



## 250# System Settings

Menu no.	Parameter no.	Parameter name	Range/ Short descr.	Default value	Description
250	01	AutoStr (Stby)		0	autostart (0 = autostart deactivated)
250	02	Dt	yyyymmdd		date (yyyymmdd)
250	03	Tm	hhmmss		time (hhmmss)
250	04	BeepEna	Off On	On	activates beeper
250	05	ClstCfg			cluster configuration from QCG, read only
250	06	ComBaud	1200 4800 9600 19200	1200	baud rate interface
250	07	ComItrf	Serial CAN	Serial	interface
250	08	ComPtcl	SMA-Data CAN CAN-Open	SMA-Data	interface protocol
250	09	ComAdr			interface address
250	10	SleepEna	Disable Enable	Enable	allows sleep mode

The „**260# Password Setting**“ menu is described in detail in section 10.5 "Entering the Installer Password" (Page 94).

## 19.3 Diagnostics

### 310# Inverter Diagnosis

Menu no.	Parameter no.	Parameter name	Range/Short descr.	Description
<b>311# Total System Diag</b>				
311	01	EgyCntIn	kWh	energy absorbed
311	02	EgyCntOut	kWh	energy fed
311	03	EgyCntTm	h	energy metering run time
<b>312# Inverter Device Diag</b>				
312	01	Adr	Master Slave1 Slave2 Slave3	device address (type) depending on the setting in QCG
312	02	FwVer		BFR firmware version
312	03	SN		serial number
312	04	OnTmh	h	operating hours
312	05	ClstCfgAt	1Phase1 1Phase2 1Phase3 1Phase4 2Phase2 3Phase 2Phase4	set cluster configuration depending on the setting in QCG
312	06	OpStt	Operating Warning Failure	operating mode (device)
312	07	CardStt	Off Operational Mount OutOfSpace  BadFileSys Incomp Parameter ParamFailed WriteLogData WriteLogFailed	MMC/SD card status message: = none Sunny Backup 5000 = in operation = card initializing = insufficient memory capacity (on card or in main directory) = incorrect file system = incompatible card = parameter update is active = error during parameter update = writing log data to card = error upon writing log data to card
312	08	FwVer2		DSP firmware version
312	09	FwVer3		BFR boot loader
312	10	FwVer4		DSP boot loader

## 320# Battery Diagnosis

Menu no.	Parameter no.	Parameter name	Range/Short descr.	Description
320	01	Soh	%	state of health (SOH), ratio of current capacity and nominal value
320	02	StatTm	d	statistics metering run time
320	03	ChrgFact		charging factor
320	04	BatEgyCntIn	kWh	energy meter for battery charge
320	05	BatEgyCntOut	kWh	energy meter for battery discharge
320	06	AhCntIn	Ah	meter for battery charging ampere hours
320	07	AhCntOut	Ah	meter for battery discharging ampere hours
320	08	BatTmpPkMin	degC	minimum battery temperature
320	09	BatTmpPkMax	degC	maximum battery temperature
320	10	EquChrgCnt		equalization charge meter
320	11	FulChrgCnt		full charge meter
320	12	BatCurOfsErr	A	current offset error of battery current
320	13	OcvPointCnt		meter for open-circuit voltage points
320	14	SilentReq	Off On	silent mode request

## 330# Backup Diagnosis

Menu no.	Parameter no.	Parameter name	Range/Short descr.	Description
<b>331# Grid Diag</b>				
331	01	GdEgyCntIn	kWh	energy meter for grid feed-in
331	02	GdEgyCntOut	kWh	energy meter for power taken from the grid
331	03	GdEgyTmh	h	run time of grid energy meter
331	04	GdOpTmh	h	operating hour meter for grid operation
331	05	GdCtcCnt		meter for grid connections
331	06	TofTmh	h	feed-in hours
<b>332# Generator Diag</b>				
331	01	GnEgyCnt	kWh	generator energy meter
331	02	GnEgyTm	h	run time of generator energy meter
331	03	GnOpTmh	h	operating hour meter for generator
331	04	GnStrCnt		number of generator starts

## 19.4 Events, Warnings and Errors (History)

Information on events and error messages [410# Failures Current, 420# Failure History and 430# Event History] are provided as of section 20.5 "Display of Errors and Events" (Page 160).

## 19.5 Functions in Operation

### 510# Operation Inverter

Menu no.	Parameter no.	Parameter name	Range/ Short descr.	Default value	Description
510	01	InvRs <b>(Stby)</b>	Restart	–	triggers inverter reset
510	02	ParaSto	Set1 Set2	–	Saves parameter settings: = file 1 = file 2
510	03	InvTmOpEna	Disable Enable	Disable	activates time-controlled inverter operation
510	04	InvTmOpStrDt	yyyymmdd	20060101	start date of time-controlled inverter operation (yyyymmdd)
510	05	InvTmOpStrTm	hhmmss	0	start time of time-controlled inverter operation (hhmmss)
510	06	InvTmOpRnDur	hhmmss	0	run time for time-controlled inverter operation (hhmmss)
510	07	InvTmOpCyc	Single Daily Weekly	Single	repeated cycle time for timer 1
510	08	ParaLod <b>(Stby)</b>	Set1 Set2 Factory	–	Loads parameter settings: = file 1 = file 2 = factory settings
510	09	CntRs	Inv Bat Gn Gd All	–	clears selected energy meter

### 520# Operation Battery

Menu no.	Parameter no.	Name	Range/ Short descr.	Default	Description
520	01	ManChrgSel	Idle Start Stop	Idle	triggers equalization charge (manual)

## 530# Operation Backup

Menu no.	Parameter no.	Parameter name	Range/ Short descr.	Default value	Description
530	02	BkupTst	Stop Start		backup system test

## 540# Operation Generator

Menu no.	Parameter no.	Parameter name	Range/ Short descr.	Default value	Description
540	01	GnManStr	Auto Stop Start Run1h ManEquChr g	Stop	manual generator start
540	02	GnAck	Ackn		error confirmation for generator fault

## 550# Operation MMC/SD Card

Menu no.	Parameter no.	Name	Range/ Short descr.	Default	Description
550	01	CardFunc	ForcedWrite StoEvtHis StoFailHis		Functions for MMC/SD card: = forces writing of data = writes event list = writes error list
550	02	DatLogEna	Off On	On	activates automatic data storage

The 600# Direct Access menu is described in detail in section 10.3 "Direct Access" (Page 91).



## 20 Troubleshooting/Problem Solving

In principle, the Sunny Backup 5000 makes a distinction between events and errors.

- **Events** describe state changes or transient states (e.g. generator connection).
- **Errors** describe impermissible or only limited permissible states. This includes warnings, failures and errors. A user interaction is generally required.

### 20.1 Error Confirmation

If a fault occurs, the Sunny Backup 5000 goes into standby mode and the fault is shown on the display.

You must remedy the cause of the fault using <ENTER> and the Sunny Backup 5000 restarts.

### 20.2 Autostart Handling

The Sunny Backup 5000 has an autostart meter that counts down by 1 for each autostart. If the Sunny Backup 5000 runs uninterrupted for over 10 minutes, the autostart meter is reset to its initial value.

If another fault occurs when the autostart meter is at 0, the Sunny Backup 5000 waits for 10 minutes and then attempts to restart. The autostart meter begins to run again.

The number of the autostarts allowed can be set using the "250.01 AutoStr" parameter (in standby mode).

### 20.3 Master Slave Handling

Each device detects the faults separately and saves it. The slaves transfer their errors to the master. The master collects these error messages and enters the slave errors as warnings into its history.

Slave 1 has detected an overtemperature fault (F138). It enters this error in its history and reports it to the master, which also enters it as a warning into its failure history ("Menu 320# Failure History").



The following message appears in the lower line on the master:

**F138 S1 Warning**

If error 138 is still active on slave 1, the Enter symbol appears at the end. After confirming the fault on the master using <ENTER>, the fault is forwarded to the corresponding slave.

Display on the master after confirmation:

**F138 S1 Warning**



The error and event memory are not compared between the master and slaves.

## 20.4 Handling Pending Errors During the Booting Procedure

During the booting procedure, all pending errors are generally confirmed without an entry being made in the history. This way, an error that is still pending after the booting procedure is re-entered or if the system detects that this error has stopped, it is entered as no longer being present.

## 20.5 Display of Errors and Events

Each error and each event have a unique three-digit display number that is created according to the parameter/measuring value assignment. The events and errors have the identical numerical range:

- 1xx - INV - Inverter
- 2xx - BAT - Battery
- 3xx - EXT - Extern
- 4xx - GEN - Generator
- 5xx - GRD - Grid
- 6xx - RLY - Relay
- 7xx - SYS - System
- 8xx - BOX - Automatic Switch Box



"F" marks an error, "W" marks a warning and "E" marks an event.

In the event of an error, and provided it is recorded, "!" is displayed for an error that has occurred and "C" is displayed for an error that has stopped.



## 20.6 Events

The meaning of events displayed by the Sunny Backup 5000 are explained in the following table:

Display no.	Description
<b>Category INV</b>	
E101	wait status
E102	startup process
E103	in operation
E104	operating on the generator (at external input)
E105	operating on the grid (at external input)
E106	feed-in grid operation (at external input)
E107	sleep mode (slave in 1-phase systems)
E108	silent mode on the grid
E110	shutting down due to fault
E115	emergency charge
E118	automatic start
E119	manual start (transfer from standby mode into operation)
E120	manual stop (transfer from operation into standby mode)
<b>Category BAT</b>	
E202	(partial) reset of BMS due to new battery
E203	state change, battery charging algorithm for float (maintenance) charge
E204	state change, battery charging algorithm for boost charge
E205	state change, battery charging algorithm for full charge
E206	state change into silent mode option
E207	state change, battery charging algorithm for equalization charge
E221	battery preservation mode level 1
E222	battery preservation mode level 2
E223	battery preservation mode level 3
<b>Category GE</b>	
E401	automatic generator start due to set criteria (battery charge state, power, time, etc.)
E402	automatic generator stop due to set criteria (battery charge state, power, time, etc.)
E403	manual generator start
E404	manual generator stop
E405	manual error confirmation of generator fault

Display no.	Description
<b>Category REL</b>	
E601	relay 1 off
E602	relay 1 on
E603	relay 1 on slave 1 off
E604	relay 1 on slave 1 on
E605	relay 1 on slave 2 off
E606	relay 1 on slave 2 on
E607	relay 1 on slave 3 off
E608	relay 1 on slave 3 on
E609	transfer relay open
E610	transfer relay closed
E611	transfer relay on slave 1 open
E612	transfer relay on slave 1 closed
E613	transfer relay on slave 2 open
E614	transfer relay on slave 2 closed
E615	transfer relay on slave 3 open
E616	transfer relay on slave 3 closed
E617	relay 2 open
E618	relay 2 closed
E619	relay 2 on slave 1 open
E620	relay 2 on slave 1 closed
E621	relay 2 on slave 2 open
E622	relay 2 on slave 2 closed
E623	relay 2 on slave 3 open
E624	relay 2 on slave 3 closed
E625	digital input OFF (Low)
E626	digital input ON (High)
<b>Category SYS</b>	
E705	device start
E706	date, time changed
E707	new system configured in QCG
E708	part 1 of the firmware updated
E709	part 2 of the firmware updated
E710	cluster firmware updated

Display no.	Description
E711	MMC/SD card inserted

## 20.7 Error Categories

The Sunny Backup 5000 categorizes errors into five different levels. There is a different behavior depending on the level:

Level	Display	Meaning
1	Warning	Warning, device continues to run. There is an explicit note on the Home Screen that a warning was recorded.
2	Malfunction	Failure that can only be detected during operation. Device switches off. Device can be restarted immediately (autostart).
3	Malfunction	Failure that can also be detected in standby mode. Device switches off. The device can only be restarted (autostart) after the system detects that the failure has stopped.
4	Failure	Device fault. Device switches off. User interaction required (troubleshooting, confirmation, manual restart).
5	Failure	Device is defect. Device switches off and does not switch on again. Permanent disable. Device must be replaced.

## 20.8 Warnings and Error Messages

The meaning of warnings and error messages displayed by the Sunny Backup 5000 are explained in the following table:

Displ. no.	Level	Description
<b>Category INV</b>		
F109	3	overheating on transformer
W110	1	overheating on transformer on slave 1
W111	1	overheating on transformer on slave 2
W112	1	overheating on transformer on slave 3
F113	3	overheating on heatsink
W114	3	overheating on heatsink on slave 1
W115	3	overheating on heatsink on slave 2
W116	3	overheating on heatsink on slave 3
F117	2	AC current limit (short-circuit control active for too long)
W118	2	AC current limit (short-circuit control active for too long) on slave 1
W119	2	AC current limit (short-circuit control active for too long) on slave 2
W120	2	AC current limit (short-circuit control active for too long) on slave 3
F121	3	inverter overvoltage

Displ. no.	Level	Description
W122	3	inverter overvoltage on slave 1
W123	3	inverter overvoltage on slave 2
W124	3	inverter overvoltage on slave 3
W137	1	derating due to temperature (heatsink or transformer)
W138	1	derating due to temperature (heatsink or transformer) on slave 1
W139	1	derating due to temperature (heatsink or transformer) on slave 2
W140	1	derating due to temperature (heatsink or transformer) on slave 3
<b>Category BAT</b>		
F201	3	measuring range of battery voltage exceeded
W202	3	measuring range of battery voltage exceeded on slave 1
W203	3	measuring range of battery voltage exceeded on slave 2
W204	3	measuring range of battery voltage exceeded on slave 3
W206	1	battery overheating
W208	3	battery overvoltage (fixed limit for cell voltage)
W210	1	battery overvoltage warning
W211	1	insufficient battery temperature warning
W212	1	high battery temperature warning
<b>Category EXT</b>		
W309	1	relay protection
W310	1	relay protection on slave 1
W311	1	relay protection on slave 2
W312	1	relay protection on slave 3
W314	1	external voltage failure
W315	1	grid/generator disconnection due to insufficient external voltage
W316	1	grid/generator disconnection due to insufficient external voltage on slave 1
W317	1	grid/generator disconnection due to insufficient external voltage on slave 2
W318	1	grid/generator disconnection due to insufficient external voltage on slave 3
W319	1	grid/generator disconnection due to excessive external voltage
W320	1	grid/generator disconnection due to excessive external voltage on slave 1
W321	1	grid/generator disconnection due to excessive external voltage on slave 2
W322	1	grid/generator disconnection due to excessive external voltage on slave 3
W323	1	grid/generator disconnection due to insufficient external frequency
W324	1	grid/generator disconnection due to insufficient external frequency on slave 1

Displ. no.	Level	Description
W325	1	grid/generator disconnection due to insufficient external frequency on slave 2
W326	1	grid/generator disconnection due to insufficient external frequency on slave 3
W327	1	grid/generator disconnection due to excessive external frequency
W328	1	grid/generator disconnection due to excessive external frequency on slave 1
W329	1	grid/generator disconnection due to excessive external frequency on slave 2
W330	1	grid/generator disconnection due to excessive external frequency on slave 3
W331	1	grid/generator disconnection due to anti-islanding
W332	1	grid/generator disconnection due to anti-islanding on slave 1
W333	1	grid/generator disconnection due to anti-islanding on slave 2
W334	1	grid/generator disconnection due to anti-islanding on slave 3
W335	1	grid/generator disconnection due to breached voltage limits
W336	1	grid/generator disconnection due to breached voltage limits on slave 1
W337	1	grid/generator disconnection due to breached voltage limits on slave 2
W338	1	grid/generator disconnection due to breached voltage limits on slave 3
F343	1	disconnection from external source
F344	1	disconnection from external source on slave 1
F345	1	disconnection from external source on slave 2
F346	1	disconnection from external source on slave 3
<b>Category GEN</b>		
W401	1	reverse power protection (generator)
<b>Category GRD</b>		
W501	1	grid reverse current prohibited (quick grid disconnection)
W502	1	grid reverse current prohibited (quick grid disconnection) on slave 1
W503	1	grid reverse current prohibited (quick grid disconnection) on slave 2
W504	1	grid reverse current prohibited (quick grid disconnection) on slave 3
<b>Category SYS</b>		
F702	1	DSP reset
F703	1	timeout during a task
F705	4	DSP watchdog has been triggered
F706	4	watchdog meter has expired (watchdog triggered several times in succession)
W707	4	watchdog meter on slave 1 has expired (watchdog triggered several times in succession)
W708	4	watchdog meter on slave 2 has expired (watchdog triggered several times in succession)
W709	4	watchdog meter on slave 3 has expired (watchdog triggered several times in succession)

<b>Displ. no.</b>	<b>Level</b>	<b>Description</b>
F710	4	autostart meter has expired (several autostarts in succession)
W713	1	watchdog has been triggered
F716	3	measuring range of battery voltage exceeded
W717	3	measuring range of battery voltage exceeded on slave 1
W718	3	measuring range of battery voltage exceeded on slave 2
W719	3	measuring range of battery voltage exceeded on slave 3
F720	4	short circuit or cable break on transformer temperature sensor
F721	4	short circuit or cable break on heatsink temperature sensor
F722	3	short circuit in battery temperature sensor
F723	3	cable break on battery temperature sensor
F731	3	error in the cluster configuration
F732	3	error in address assignment of cluster device
F733	3	no message from cluster master (only slave)
W734	3	no message from cluster on slave 1
W735	3	no message from cluster on slave 2
W736	3	no message from cluster on slave 3
W738	1	synchronization not successful
F739	3	internal device communication BFR-DSP missing
W740	3	internal device communication BFR-DSP on slave 1 missing
W741	3	internal device communication BFR-DSP on slave 2 missing
W742	3	internal device communication BFR-DSP on slave 3 missing
F743	3	internal device communication BFR-DSP missing
W744	3	internal device communication BFR-DSP on slave 1 missing
W745	3	internal device communication BFR-DSP on slave 2 missing
W746	3	internal device communication BFR-DSP on slave 3 missing
W747	4	short circuit or cable break on transformer temperature sensor on slave 1
W748	4	short circuit or cable break on transformer temperature sensor on slave 1
W749	4	short circuit or cable break on transformer temperature sensor on slave 2
W750	4	short circuit or cable break on heatsink temperature sensor on slave 2
W751	4	short circuit or cable break on heatsink temperature sensor on slave 3
W752	4	short circuit or cable break on heatsink temperature sensor on slave 3
F753	1	invalid system time

Displ. no.	Level	Description
<b>Category BOX</b>		
F801	3	box fault
W802	1	PV system not available
W803	1	PV system not available for grid feeding
W804	1	no grid operation
W805	1	no generator operation
F806	4	box type (Sunny Backup 5000) and box type (Automatic Switch Box) do not match
W807	1	external voltage is invalid

## 20.9 Troubleshooting

Answers are provided below for faults that may occur in practice:

### 1. Approval

**The grid operator refuses to allow connection of the system to the grid due to concern that this would enable feeding of arbitrary current back through the feed-in counter. Is this legitimate?**

No, if all system components are connected correctly, only energy which is fed in at connection X4 / PV System can be forwarded to the output X5 / PV Meter. A connection from the Sunny Backup 5000 to the PV feed-in counter is prevented by the software, and also by the hardware locks in the box.

### 2. Installation / Commissioning

**Why do I need to install a fuse in the Automatic Switch Box? The cable from the grid is already fused in the meter cabinet!**

So that the cable from the Automatic Switch Box to the consumer system is protected against overload in stand-alone operation. The Sunny Backup 5000 and the PV system combined can supply more power than is provided for on the grid side.

**Why do thermal fuses need to be installed in the Automatic Switch Box? These days, only automatic breakers are used!**

For two reasons: firstly, you must select the nominal fuse rating according to the system's local conditions, thus SMA Technologie AG cannot install a line circuit breaker with a fixed nominal rating. Secondly, if a line circuit breaker were installed, in the event of a short circuit during feeding from a rigid grid (high short-circuit currents!), there would be no selectivity between that line circuit breaker and the line circuit breakers in the sub-distribution unit, even if it were to have a higher nominal rating. However, there is selectivity between thermal fuses and line circuit breakers, so that upon a short circuit in the final circuit, only the fuse in the final circuit blows, and not the fuse in the Automatic Switch Box as well.

**How do I dimension the thermal fuses in the Automatic Switch Box?**

The dimensioning of the thermal fuse at the loads output (X3 / Backup Loads) is made easier by the following recommendations:

- **A:** The rating of the back-up fuse in the meter cabinet is equal to the nominal current of the Automatic Switch Box during grid operation.
  - For the Automatic Switch Box, a fuse must be installed with a rating which corresponds to the nominal current of the Automatic Switch Box (35 A for Automatic Switch Box M, 63 A for L, and 160 A for XL).
- **B:** The rating of the back-up fuse in the meter cabinet is lower than the nominal current of the Automatic Switch Box during grid operation.
  - The fuse to be installed must be the same as in the meter cabinet.



- The maximum current drawn from the grid (parameter "232.03 GdCurNom") is to be set to the rating of the back-up fuse.
- **C:** The rating of the back-up fuse in the meter cabinet is higher than the nominal current of the Automatic Switch Box in grid operation, and the cables are designed for larger currents accordingly.
  - There is a danger of overloading the Automatic Switch Box. If possible, install a fuse, with a rating equal to the nominal current of the Automatic Switch Box, in the meter cabinet at the output leading to the Automatic Switch Box.
  - For the Automatic Switch Box, a fuse must be installed with a rating which corresponds to the nominal current of the Automatic Switch Box (35 A for Automatic Switch Box M, 63 A for L, and 160 A for XL).

### **Why am I prohibited from installing an RCD upstream of the Sunny Backup system?**

Because the RCD has a protective function (voltage disconnection in the event of a fault) which is rendered ineffective by the Sunny Backup system. In order to preserve this protective function, the RCD must be positioned between the Automatic Switch Box and the loads.

### **Why do I need the PEN conductor to be grounded upstream of the Sunny Backup system, yet still within the system? The PEN conductor is already grounded in the local grid!**

In the event of a deliberate grid shutdown on the part of your distribution grid operator (e.g. for maintenance work), the PEN conductor can be interrupted if the corresponding phase conductors are disconnected. The Sunny Backup system then lacks a ground connection, which is unacceptable, both in terms of functionality and safety. Furthermore, an increase of the PEN conductor's voltage in the grid is prevented in stand-alone operation.

### **At our site, there is only a TT grid, and my distribution grid operator does not allow the N conductor to be grounded. Can I operate the Sunny Backup system anyway, without grounding the N conductor?**

NO, in this form, the system is only certified for TT grids. Consult your energy supply company to ascertain the conditions under which installation is permissible.

### **What happens if three-phase loads remain connected in a single-phase Sunny Backup system (e.g. Automatic Switch Box M)?**

In this case, both the X1 / Load Meter and X3 / Backup Loads connections must be implemented as three-phase connections. Thus, three-phase grid disconnection occurs, but in the event of grid failure, power supply continues only at phase L1. This means that reverse voltage on the grid side is not possible.

If the three-phase loads are star-connected, these continue to be powered on just a single phase. For electric kitchen stoves, which often have a three-phase connection, this is not at all problematic. In motors which are nevertheless connected, and which are protected by a motor overload switch, this motor overload switch will generally be

triggered. Otherwise, the motor will either not start at all, or will operate very irregularly, and should be deactivated again immediately because otherwise the Sunny Backup system may deactivate due to overloading.

With three-phase delta-connected loads (e.g. electric continuous-flow heaters) which are kept in operation in a single-phase Sunny Backup system, reverse voltages will occur on the other phases, and the Sunny Backup system will probably be overloaded. In the event of a grid failure, loads such as these may not be kept in operation, and must be clamped upstream of the Automatic Switch Box's X1 / Load Meter connection.

### **Why must I set the Sunny Boy to use "stand-alone grid parameters"? It has operated without problems up to now!**

As long as your system is operating on the public grid, the high power output from connected power stations means that the public grid can ensure that voltage and frequency do not change if you connect loads to the grid. In a small stand-alone grid, in which the consumer power is about the same as the inverters' installed capacity, such effective adjustment is not possible. Therefore, frequency and voltage are not as constant as in the so-called "rigid grid", so the Sunny Boys in stand-alone grid operation would often interpret these deviations as grid faults and deactivate. To enable practical utilization of the PV system in the event of grid failure, it must also be able to operate in a "soft" grid. This is made possible by means of switching to the so-called "stand-alone grid parameters".

### **But the Sunny Boy also feeds into the grid. Is that permissible with the "grid parameters" deactivated?**

This is permissible for the Sunny Boy, or any other PV inverter, but only in conjunction with the upstream Sunny Backup system, or a certified automatic disconnection device as defined for example in the DIN VDE 0126-1-1 Standard for Germany. The Sunny Boy may not operate directly on the grid in this manner, because it must adhere to the parameters (voltage and frequency limits) specified by e. g. DIN VDE 0126-1-1, and must also contain the automatic disconnection device specified by that standard. The Sunny Boy meets both these requirements with its integrated "SMA grid guard version 2". Only once the Sunny Boy is connected to the Sunny Backup system's X4 / PV System input, may "SMA grid guard version 2" be deactivated because its functions are then assumed by the control and monitoring within the Sunny Backup system.

### **Can I also connect a generator to the Automatic Switch Box with a plug?**

No, a prerequisite for the optional use of generators is a fixed connection to the respective generator. If a plug system (CEE) is used, and a plug is pulled out during operation, life-threatening reverse voltages briefly arise at the plug for up to 5 seconds.

### **What can I do if the QCG suddenly does not run?**

Switch off the Sunny Backup 5000 (section 9.3 "Deactivation" (Page 83)) and switch it back on (section 9.1 "Activation / Startup" (Page 81)).

### 3. Operation

#### **How can a failure of the public grid be signaled?**

A light indicator, or similar device, can be controlled via one of the Sunny Backup 5000's two internal relays in such a manner that the light indicator is only activated in the event of a grid failure. For instance, relay 1 can be set to "GdOn" via parameter "241.01 Rly1Op". In turn, an indicator light is switched via the floating contact.

#### **How can it be signaled that the battery's charge level is low?**

A light indicator, or similar device, can be controlled via one of the Sunny Backup 5000's two internal relays in such a manner that the light indicator is only activated when the battery's charge level is low. For instance, relay 2 can be set to "AutoLodSoc1" via parameter "241.02 Rly2Op". With the parameter "242.01 Lod1SocTmStr", the activation value can be set to 30 %, for example, and with the parameter "242.02 Lod1SocTmStp" the deactivation value can be set to 50 %, for example.

#### **How can I determine whether my Sunny Backup system is operating correctly?**

The display on the Sunny Backup 5000 clearly indicates the system status (see section 10.6 "Display Messages (Overview)" (Page 96)). In addition, the battery's charge level should be between 95 % and 100 %. If a warning is indicated (exclamation mark "!" in the lower right-hand corner of the display), the status of the Sunny Backup system must be analyzed in more detail.

#### **How can I determine whether the Sunny Backup system is operating in stand-alone operation?**

The display indicates that a grid failure has occurred (see section 10.6 "Display Messages (Overview)" (Page 96)).

#### **How can I test whether my Sunny Backup system will "jump in" if the grid fails?**

The functionality of the Sunny Backup system can be tested at any time with the "Test Backup System" function (see section 18.7 "Sunny Backup System Test" (Page 140)).

#### **In the mornings and evenings, I hear switching noises in the Automatic Switch Box. Is the Sunny Backup system switching to stand-alone operation every day?**

No, but at night the PV contactors are deactivated in order to reduce operating consumption.

#### **I have discovered that if I simply switch off the Sunny Backup 5000 while the grid is available, my loads are still powered. But why does my PV system not begin to feed?**

Grid monitoring is guaranteed by the Sunny Backup 5000, and not by the Sunny Boy. The Sunny Backup 5000 must be switched on in order for this monitoring to be performed.

### **Why is my battery discharging, even though the grid is available?**

The Sunny Backup system limits the power drawn from the grid to the defined maximum grid current (parameter "232.03 GdCurNom"). If the total current of all loads exceeds this value, the loads are supplied with additional power from the battery. If possible, increase the grid current value.

### **Why is it not possible to change the parameters?**

- Has the installer password been entered correctly? Check whether you are actually in "Installer Level" (see section 10.5 "Entering the Installer Password" (Page 94)). If necessary, repeat the calculation and entry of the password.
- You are in the "100-Meters" (measuring data) menu or the "300-Diagnosis" (Diagnosis) menu. You can only read the data values shown here.
- Some parameters can only be changed in standby mode or in the QCG (see e.g. the "242.07 GnStrMod" parameter in section 19.2 "Adjustable System Parameters" (Page 145)). Stop the Sunny Backup 5000 as described in section 9.2 "Stopping" (Page 82). Note that this causes the PV system to fail, and grid feeding is not possible.

### **Why is the stand-alone grid frequency not at 50 Hz?**

- The Sunny Boy inverter is controlled via the frequency (see section 17.2 "Frequency Shift Power Control (FSPC)" (Page 137)).
- Power fluctuations cause frequency deviations.

## **4. Errors**

### **Why is the display of the Sunny Backup 5000 dark and why is nothing shown on the display?**

- Is the DC circuit breaker on the Sunny Backup 5000 set to "On"?  
In this case, the device has switched off to protect the battery against deep discharge (see also section 14.3 "State of Charge/SOC and SOH" (Page 116)). To reactivate the Sunny Backup 5000, see section 9.5 "Reactivating the Device Following Automatic Shutdown" (Page 84).
- The external battery fuse may have been triggered.

### **Why does the "VAC-Low" error (output voltage too low) also occur when the Sunny Backup 5000 is started?**

- A permanent short circuit exists in the consumer grid. Check the AC output connections and fuses (X3 / Backup-Loads).
- The loads connected during the grid failure are too heavy. The power of the Sunny Backup 5000 is not sufficient to supply the loads. Switch off some of the loads and restart the Sunny Backup 5000.

### **What happens when a battery cell can no longer be used?**

Remove the unusable cell from your battery bank. Then start the Sunny Backup 5000 and change the battery voltage in the QCG under "New Battery". This is not possible if 12 V battery blocks are used.

**What happens when "MMC operation failed" appears on the display?**

You wanted to perform an action using the MMC/SD card, but it failed (see section 10.10 "Display of Warnings and Errors" (Page 100)). Check the card (on your PC/laptop) and use a new MMC/SD card, if necessary.

**Why is the SOC not at 100 %, even after completion of a full charge?**

Set a longer absorption period.

**What do I have to do if the Sunny Backup 5000 continuously goes out after Low Battery Mode (LBM) when restarting the device?**

Upon reactivation, ensure that either the public grid is available again, or that battery charging is possible via the PV system, or via a generator. Otherwise, after 5 minutes without a charging current, the Sunny Backup 5000 returns to battery preservation mode, and switches back to standby.

**What happens if the card inserted is not FAT16-formatted?**

The Sunny Backup 5000 displays the message "Incomp". Use a PC to format the card.

**Why does the generator or grid not reconnect, although the cutoff limit (for voltage or frequency) is now no longer being breached?**

The Sunny Backup 5000 switches with so-called hysteresis, i.e. the reconnection limit is somewhat beyond the cutoff limit. These threshold values are predefined ex works.

**Why is the Sunny Backup 5000 not connecting to the running generator?**

- Is the fuse on the generator ok?
- Has the power allowed to be fed back into the generator during the permissible time been exceeded ("242.14 GnRvTm" parameter)? If yes, "!" appears on the display. Generator connection is blocked for the set time. Set the "430.02 GnAck" parameter to Ackn.
- If the generator control relay (GnReq) is open:
  - Was the generator started manually ("242.07 GnStrMod" parameter)? Change the setting here to autostart, if required.

**Why does the Sunny Backup 5000 only ever connect to the generator for a brief time?**

The limits for the maximum permissible AC voltage or the minimum permissible frequency of the generator are too strict (parameter in menu "242# General Settings"). Change voltage and/or frequency limits according to the technical data of your generator.

**I have just installed the system and wanted to test the battery grid feeding feature, however no power is exported into the grid?**

After the installation of the Sunny Backup System or the installation of a new battery, the battery management assumes a SOC of 50 %. After five hours the system will carry out a full charge and the export of energy is possible. Another option to test the battery grid feeding instantly is to change the defaults values of the minimal SOC where the feeding is started and stopped.

## 21 Technical Data

### 21.1 Sunny Backup 5000

Output data	
Nominal AC voltage ( $U_{AC, nom}$ ) (adjustable)	230 V (202 to 253 V)
Nominal frequency ( $f_{nom}$ )	45 to 65 Hz
Continuous AC output ( $P_{nom}$ ) at 25 °C	5000 W
Continuous AC output ( $P_{nom}$ ) at 45 °C	4000 W
AC output power for 30 min at 25 °C	6500 W
AC output power for 5 min at 25 °C	7200 W
AC output power for 1 min at 25 °C	8400 W
Nominal AC current ( $I_{AC, nom}$ )	21 A
Max. current (peak value) for 100 ms	100 A (100 ms)
Harmonic distortion of output voltage ( $K_{VAC}$ )	< 3 %
Power factor $\cos\varphi$	-1 to +1
Input data	
Input voltage ( $U_{AC, ext}$ ) (adjustable)	230 V (172.5 to 250 V)
Input frequency ( $f_{ext}$ ) (adjustable)	50 Hz (40 to 60 Hz)
Max. AC input current ( $I_{AC, ext}$ ) (adjustable)	56 A (2 to 56 A)
Max. input power ( $P_{AC, ext}$ )	12.8 kW
Battery data	
Battery voltage ( $U_{Bat, nom}$ ) (adjustable)	48 V (41 to 63 V)
Max. battery charging current ( $I_{Bat, max}$ )	120 A
Continuous charging current ( $I_{Bat, nom}$ )	100 A
Battery capacity	100 to 10000 Ah
Charge control	IUoU process with automatic full and equalization charge
Battery type	VRLA/FLA/NiCd

Efficiency / Power consumption																											
Max. efficiency	95 % (at 1000 W)																										
Efficiency >90 %	5–120 % P <sub>nom</sub>																										
<p>Efficiency measurement 230 V device (5kW load, 300 A DC shunt)</p> <table border="1"> <caption>Approximate data points from the efficiency graph</caption> <thead> <tr> <th>Output power P2 [W]</th> <th>Efficiency</th> </tr> </thead> <tbody> <tr><td>0</td><td>0.80</td></tr> <tr><td>250</td><td>0.85</td></tr> <tr><td>500</td><td>0.90</td></tr> <tr><td>1000</td><td>0.95</td></tr> <tr><td>1500</td><td>0.95</td></tr> <tr><td>2000</td><td>0.94</td></tr> <tr><td>2500</td><td>0.93</td></tr> <tr><td>3000</td><td>0.92</td></tr> <tr><td>3500</td><td>0.915</td></tr> <tr><td>4000</td><td>0.91</td></tr> <tr><td>4500</td><td>0.905</td></tr> <tr><td>5000</td><td>0.90</td></tr> </tbody> </table>		Output power P2 [W]	Efficiency	0	0.80	250	0.85	500	0.90	1000	0.95	1500	0.95	2000	0.94	2500	0.93	3000	0.92	3500	0.915	4000	0.91	4500	0.905	5000	0.90
Output power P2 [W]	Efficiency																										
0	0.80																										
250	0.85																										
500	0.90																										
1000	0.95																										
1500	0.95																										
2000	0.94																										
2500	0.93																										
3000	0.92																										
3500	0.915																										
4000	0.91																										
4500	0.905																										
5000	0.90																										
Operating consumption with no load (in standby mode)	25 W (< 4 W)																										
Certification																											
	CE IEC 60335-1																										
Germany	DIN VDE 0126-1-1 DIN EN 50178 DIN EN 61000-3-2 DIN EN 61000-6-1 DIN EN 61000-6-2 DIN EN 61000-6-3 DIN EN 61000-6-4																										
Australia	AS 4777																										
Protection rating																											
According to DIN EN 60529	IP 40 (with inserted MMC/ SD card) otherwise IP 30																										
Device protection																											
	short circuit, overload, overheating																										



<b>Interfaces</b>	
	2 LEDs, 4 buttons, two-line display, 2 multi-function relays, RS485/RS232 galvanically isolated (opt.), MMC/SD card
Digital input level (Dig-In)	high level as of 9 V (up to 63 V), low level 0–3 V
Load limits for multi-function relays 1 and 2	AC: 1 A at 250 V~ DC: see graphic
<p style="text-align: center;"><b>Load Limit Curve</b></p> <p>The graph shows the relationship between voltage and current for the multi-function relays. The y-axis represents voltage in Volts [V] on a logarithmic scale from 10 to 400. The x-axis represents current in Amperes [A] on a logarithmic scale from 0.1 to 5. The curve starts at 300V for 0.1A and decreases to approximately 40V at 5A. A point on the curve at approximately 0.5A and 50V is labeled 'DC resistive load'.</p>	
<b>Switching time</b>	
max. time	20 ms
<b>Mechanical data</b>	
Width x height x depth	(467 x 612 x 235) mm
Weight	approx. 63 kg
<b>Ambient conditions</b>	
ambient temperature	-25 °C to +50 °C
<b>Miscellaneous</b>	
Waranty (EU)	5 years
<b>Accessories</b>	
Ext. battery temperature sensor	included

Generator manager (GenMan)	optional
----------------------------	----------

## 21.2 Automatic Switch Box

### Type M

Input and output data	
Nominal AC voltage	230 V
Nominal frequency	50 Hz
Nominal AC power PV	5,7 kW
Nominal AC current PV	25 A
Nominal AC power consumer (on-grid operation)	8 kW
Nominal AC current consumer (on-grid operation)	35 A
Power consumption	
Consumption during the day	21 W
Consumption at night	16 W
Mechanical data	
Width x height x depth	(600 x 600 x 210) mm
Weight	approx. 29 kg
Ambient conditions	
Ambient temperature	-25 °C ... +50 °C
Certification	
	CE
Protection rating	
According to DIN 60529	IP 65

### Type L

Input and output data	
Nominal AC voltage	400 V
Nominal frequency	50 Hz
Nominal AC power PV	30 kW
Nominal AC current PV	3 x 44 A
Nominal AC power consumer (on-grid operation)	44 kW

Nominal AC current consumer (on-grid operation)	3 x 63 A
<b>Power consumption</b>	
Consumption during the day	42 W
Consumption at night	32 W
<b>Mechanical data</b>	
Width x height x depth	(600 x 760 x 210) mm
Weight	approx. 41 kg
<b>Ambient conditions</b>	
Ambient temperature	-25 °C ... +50 °C
<b>Certification</b>	
	CE
<b>Protection rating</b>	
According to DIN 60529	IP 65

## Type XL

<b>Input and output data</b>	
Nominal AC voltage	400 V
Nominal frequency	50 Hz
Nominal AC power PV	110 kW
Nominal AC current PV	3 x 160 A
Nominal AC power consumer (on-grid operation)	110 kW
Nominal AC current consumer (on-grid operation)	3 x 160 A
<b>Mechanical data</b>	
Width x height x depth	(1000 x 1400 x 300) mm
Width x height x depth (with base)	(1000 x 1600 x 300) mm
Weight	approx. 180 kg
<b>Ambient conditions</b>	
Ambient temperature	-25 °C ... +50 °C
<b>Protection rating</b>	
According to DIN 60529	IP 65

## 21.3 Battery Connection Box (SBU-CON.33)

Mechanical data	
Width x height x depth	(375 x 250 x 150) mm
Width x height x depth (with screw connections)	(375 x 350 x 150) mm
Weight	approx. 20 kg

## 22 Certificates

### EC Declaration of Conformity in terms of the Guidelines of the European Community



- Electromagnetic Compliance 89/336/EWG as modified with 93/31/EWG
- Low Voltage Regulation 73/23/EWG

The devices stated below have been developed, constructed and manufactured according to the above mentioned EC directives. The applied harmonized standards are shown in the following table.

Sunny Backup	
SBU 5000	
<b>Emission:</b>	
DIN EN 61000-6-3: 2002-08	x
DIN EN 61000-6-4: 2002-08	x
<b>Utility Interference:</b>	
DIN EN 61000-3-2: 2001-12	x
DIN EN 61000-3-12: 2004-06	x
<b>Immunity:</b>	
DIN EN 61000-6-1: 2002-08	x
DIN EN 61000-6-2: 2002-08	x
<b>Safety:</b>	
DIN EN 50178: 1998-04	x

Note:  
This declaration of conformity is not valid any longer,  
• if the product is modified, supplemented or changed in any other way,  
• components, which are not part of the SMA accessories kit, are integrated in the product,  
as well as in case the product is used or installed improperly.

SMA Technologie AG  
Hannoversche Strasse 1-5  
D-34266 Niestetal  
Tel. +49 561 9522-0  
Fax +49 561 9522-100  
info@SMA.de  
www.SMA.de

Niestetal, 20.03.2007  
SMA Technologie AG

i.V. Andreas Berger  
(Head of Development EIES)

CE\_SBU5000-11.BE1.207



# EC Declaration of Conformity

in terms of the Guidelines of the European Community



- Electromagnetic Compliance 89/336/EWG as modified with 93/31/EWG
- Low Voltage Regulation 73/23/EWG

The devices stated below have been developed, constructed and manufactured according to the above mentioned EC directives. The applied harmonized standards are shown in the following table.

Sunny Backup	
AS-Box-M AS-Box-L	
<b>Emission:</b>	
DIN EN 61000-6-3: 2002-08	<b>x</b>
DIN EN 61000-6-4: 2002-08	<b>x</b>
<b>Immunity:</b>	
DIN EN 61000-6-2: 2002-08	<b>x</b>
DIN EN 61000-6-1: 2002-08	<b>x</b>
<b>Utility Interference:</b>	
DIN EN 61000-3-12: 2004-06	<b>x</b>
<b>Safety:</b>	
DIN EN 50178: 1998-04	<b>x</b>

The above mentioned devices furthermore are compliant with the following standards:

- DIN VDE V 0126-1-1: 2006-02
- DIN VDE 0100-410: 2007-6
- DIN VDE 0100-551: 1997-08

Note:  
 This declaration of conformity is not valid any longer,  
 • if the product is modified, supplemented or changed in any other way,  
 • components, which are not part of the SMA accessories kit, are integrated in the product,  
 as well as in case the product is used or installed improperly.

SMA Technologie AG  
 Hannoversche Strasse 1-5  
 34266 Niestetal, Germany  
 Tel. +49 561 9522-0  
 Fax +49 561 9522-100  
 info@SMA.de  
 www.SMA.de

Niestetal, 19.07.2007  
 SMA Technologie AG

i. V. Jürgen Reekers  
 (Head of Department SUP)

CE\_ASBOX11\_BBE2907



## 23 Contact

If you have any questions or queries, please contact us. A team of qualified engineers and technicians is at your disposal. Please have the following information at hand when you call us:

- Inverter type (Sunny Backup 5000, see name plate)
- Voltage/frequency type
- Serial number (see name plate or parameter "312.03 SN")
- Firmware version (see parameter "312.02 FwVer")
- Error message shown on the display
- Battery type
- Nominal battery capacity
- Nominal battery voltage
- Communication products used
- Type and size of additional energy sources (generators, PV systems, PV inverters)
- If a generator exists:
  - generator type
  - generator capacity
  - maximum generator current
  - generator interface

Always use the MMC/SD card to save data and events. This is necessary in order for **SMA Technologie AG** to be able to help you in the event of a fault. To ensure that you have saved the present error list and event list on the MMC/SD card, write all data to the MMC/SD card with the parameter "440.01 CardFunc" and the option "ForceWrite".



SMA Technologie AG  
Hannoversche Strasse 1 - 5  
34266 Niestetal  
Germany  
Tel. (+49) 561 95 22 - 399  
Fax (+49) 561 95 22 - 4697  
SunnyIsland.Service@SMA.de  
www.SMA.de

## 24 Glossary

### Absorption phase

Constant V phase: a charging phase using constant charging voltage. The charging current constantly decreases during this phase.

### AC

Abbreviation for "Alternating Current".

### AC coupling

The connection of various loads, generators and storage devices on the AC side.

### AGM battery

Absorbent glass mat separator battery. This is a battery where the electrolyte (a mixture of water and sulfuric acid) is bound to a glass fiber mat, a type of closed lead acid battery. A gas mixture (hydrogen and oxygen) is always generated when lead acid batteries are charged, and in normal operation this is internally recombined to form water. This removes the need for regularly refilling the battery cells with water, which is why these batteries are often described as "low maintenance" or even "maintenance free". AGM batteries are available from many different manufacturers for a wide range of applications. They usually have very good high current properties but are not very charge-cycle resistant.

### Ah

Abbreviation for "ampere hours": unit of electrical charge, one ampere hour is the charge provided by a constant current of 1 A over a period of one hour - when two separate charges are connected.

### Automatic disconnection device

The "automatic disconnection device between a grid parallel power-generating system and the public low voltage grid" is an equivalent replacement for a normal public disconnection device with isolation function which is accessible to the distribution grid operator at any time. This is a mandatory safety device which prevents energy from a solar power system being fed into an external power grid when the external power generator is not functioning. In the Sunny Boy / Sunny Mini Central, this function is performed by the "SMA grid guard Version 2". In the Sunny Backup 5000, it is integrated in the Automatic Switch Box.

### Automatic Switch Box

Switching device which switches a Sunny Backup system between grid operation and stand-alone grid operation. In the Sunny Backup system, during grid operation a PV system is operated via an automatic disconnection device at its own feed-in counter; upon grid failure, it is switched to the stand-alone grid which is disconnected from the public grid. As an option, the box can also integrate a diesel generator into the Sunny Backup system.



## **Backup system**

Backup systems are power supply systems which provide an extra level of security for standard power supply systems. The public grid is usually the standard power supply system, which is backed up by an additional stand-alone grid system in case of a power outage. In addition to the backup systems, diesel generators in PV battery systems are also described as backup generators. Here they perform the same task as a backup system for the public grid.

## **Battery**

A battery is an electrochemical storage device which can release previously stored chemical energy as electrical energy. A distinction is made between non-rechargeable primary elements (often used in (e.g.) consumer markets) and rechargeable secondary elements (accumulators). In stand-alone grid systems, the batteries used as rechargeable secondary elements are almost exclusively lead acid batteries and, very rarely, nickel/cadmium batteries.

## **Battery bank**

See Battery system

## **Battery charging mode**

A battery inverter operating mode, in which the inverter takes energy from the AC grid to recharge the battery in a controlled fashion. In this operating mode, the battery inverter is primarily responsible for correctly charging the battery, and acts as an independent battery charger.

## **Battery inverter**

See Battery power converter

## **Battery management**

The battery management is responsible for optimal battery charging and reliable protection against deep discharge. This is the only way of ensuring that the battery service life reflects the manufacturer's specifications.

## **Battery power converter**

A bidirectional power converter which can regulate voltage and frequency in a stand-alone grid and is also responsible for correct battery charging.

## **Battery system**

Series connection and possibly also parallel connection of several identical batteries. Battery banks of 12 V, 24 V, 48 V and 60 V are typical.

## **Boost charge**

Boost charge: allows the batteries to be charged to a level of approx. 85 - 90 % in the shortest time and the most efficient manner.

## Bulk phase

I phase: the charging phase in which charging can be done using the maximum allowable charging current.

## Capacity

Describes the storage capability of a cell or battery, specified in Ah (ampere hours). The capacity of a battery is heavily dependent on the charging cycle, the amount of current drawn and the temperature.

## Central inverter

An inverter concept in which all PV modules are connected to each other (in series and/or parallel) and which uses a single inverter for feeding energy into the external grid. The lower cost of the inverter is usually offset by the much higher installation outlay required and possible yield losses due to variations in shadowing on individual solar modules.

## Charge level

Describes the present amount of charge which can be drawn from the battery, in percent of the nominal capacity (100 % = battery full, 0 % = battery empty).

## Charge mode

See Battery charging mode

## Charging throughput

See Nominal charging throughput

## Cluster

Several Sunny Island or Sunny Backup inverters which are connected in parallel on the DC side, and which are connected to a shared battery system. On the AC output side, these inverters can also be connected in parallel (single-phase system), or form a multi-phase system. The devices in a cluster must be connected by communication cables, and must be configured in such a manner that one device (-> master) leads the cluster, and all other devices (-> slaves) communicate with the leading device.

## C rate

The nominal capacity specification is always provided along with the discharge time on which the capacity is based. The nominal capacity is the product of the constant charging current  $I_N$  and the discharge time  $t_N$ , which passes between commencement of discharging the fully charged battery and when the final discharge voltage  $U_S$  is reached. For stationary batteries, the  $C_{10}$  capacity is usually specified, i.e. a battery with  $C_{10} = 200$  Ah can be discharged for 10 hours at a nominal current of  $0.1 \times C_{10} = I_{10} = 20$  A.

## DC

Abbreviation for "Direct Current".

## Derating

English for "reduction": a controlled reduction in performance, usually dependent on component temperatures. Compared with the (also common) practice of completely shutting down the device, the effect on the external grid is smaller with derating.

## DSP

Abbreviation for Digital Signal Processor. A DSP is a microprocessor chip especially developed for digital signal processing and control.

## Electrolyte

Allows the conduction of ions within a battery. In a lead acid battery, the electrolyte is diluted sulfuric acid and is also a reactant in the electrochemical reaction. Nickel/cadmium batteries use an alkaline electrolyte (potassium hydroxide).

## EPROM

See Flash EEPROM

## Equalization charge

See Equalize charge

## Equalize charge

Equalization charge: allows multiple series-connected battery cells to be charged to a unified charge level of 95 - 100 %. Without regular equalization charging, the charge states of the individual cells slowly drift apart, which can lead to premature battery bank failure.

## Firmware

Firmware is software which is embedded in a chip in various electronic devices, such as hard disk recorders, DVD burners and players, newer television sets, household appliances and computers - in contrast to software, which is stored on hard drives, CD-ROMs or other media. These days, firmware is usually stored in a flash memory or an EEPROM.

## FLA

Flooded lead acid battery: a lead acid battery with liquid electrolyte, also often described as a closed lead acid battery.

## Flash EEPROM

The abbreviation EEPROM stands for Electrically Erasable Programmable Read-Only Memory. Flash memories are digital storage devices (chips). The exact designation is "flash EEPROM". In contrast to "normal" EEPROM memories, in flash EEPROM it is not possible to delete individual bytes (the smallest addressable memory units).

EEPROM is a non-volatile, electronic memory component used (for example) in computer technology, and mainly in embedded systems.

Flash EEPROMs are used where information must be permanently stored in the smallest amount of space, e.g. for storing the firmware.

## Float charge

Maintenance charge: allows the batteries to be slowly charged to a charge level of 100 % without the negative effects of overcharging. Complete charging to 100 % using float charge takes several days. For this reason, float charging is more important for grid backup systems and less important for stand-alone grids.

## Full charge

Full charge: recharging of the batteries to a level of approx. 95 % on a regular basis (at least once a month). This efficiently avoids premature battery aging caused by inadequate charging.

## Gel battery

A type of battery in which the electrolyte (a mixture of water and sulfuric acid) is bound into a gel. This is a type of so-called closed lead acid battery. A gas mixture (hydrogen and oxygen) is always generated when lead acid batteries are charged, and in normal operation this is internally recombined to form water. This removes the need for regularly refilling the battery cells with water, which is why these batteries are often described as “low maintenance” or even “maintenance free” (see also AGM battery). Gel batteries are available from many different manufacturers for a wide range of applications. There are gel batteries for high-current applications but also for cycle operation with very high cycle resistance.

## Generator

An electrical generator is an electrical machine which converts kinetic or mechanical energy into electrical energy. Here, not only the electrical generator itself, but also the combustion unit (diesel, petrol, or gas motor) necessary for the power unit is combined together with the electrical generator and simplified under the term “generator”. This is also described colloquially as a power generator.

## Grid-connected system

PV system which is connected to the power supply grid of an external energy supplier.

## Inverter

A device for converting the direct current (DC) from the PV generator into alternating current (AC), which is necessary for connection of most normal household devices and especially for feeding solar energy into an existing supply grid. Inverters for PV systems usually include at least one MPP tracker, store operating data, and monitor the grid connection of the PV system (see also MSD).

## Inverter mode

Operating mode of a battery inverter where it supplies the stand-alone grid from the battery energy. In this operating mode, the battery inverter is especially responsible for the control of frequency and voltage in the stand-alone grid.

## **Main cluster**

The leading cluster in a multicluster system. The main cluster, for example, has the tasks of voltage and frequency regulation, grid monitoring, generator control, load management, and control of the Automatic Switch Box in a backup system.

## **Maintenance charge**

See Float charge

## **Master**

A configuration setting which assigns the leading role in a cluster to a Sunny Island or Sunny Backup inverter. This stipulates that centralized control and monitoring tasks, which in a cluster must be performed by just one device (e.g., frequency regulation, battery management, generator control, and control of the Automatic Switch Box in the Sunny Backup system) are to be performed by this device. All other inverters of the cluster must be configured so as to leave these tasks to the master, and to be led by the master (-> slaves). The master is also the device at which the cluster's configuration, operation, and data recording occurs in a centralized manner.

## **Maximum Power Point "MPP"**

The operating point (defined current/voltage curve) of a PV generator where the maximum power can be drawn. The actual MPP changes constantly depending, for example, on the level of solar irradiation and the ambient temperature.

## **MPP tracker**

Regulation of the power drawn so that a PV generator is operated for as long as possible at the MPP. This operating point varies with the solar irradiation and temperature conditions of the modules. MPP tracking optimizes the extraction of electrical power and is a feature of inverters and charge controllers.

## **MSD**

See Automatic disconnection device

## **Multicluster system**

Parallel connection of several clusters on the AC output side in a stand-alone grid or backup system. The master devices of the individual clusters must be connected by communication cables, and configured in such a manner that one cluster leads the entire system (see main cluster) and the master devices of all other clusters (see sub-cluster) communicate with the master of the main cluster.

## **Multi-string inverter**

An inverter which to a great extent combines the advantages of several string inverters (separate MPP tracking of individual strings) and a central inverter (low performance-specific costs).

## NiCd

Nickel/cadmium battery, contains nickel, cadmium, and potassium hydroxide as the electrolyte. These require a significantly higher charging voltage, have a lower level of efficiency and are significantly more expensive than lead acid batteries. However, their robustness, cycle resistance and low-temperature capabilities mean that they are used in certain special applications.

## NLM

Abbreviation for Powerline modem: communication between SMA inverters and the monitoring devices can be made with a cable, a radio link, or a Powerline modem. Powerline modems use a carrier frequency of approx. 132 kHz modulated onto the AC cables, and data is transferred using FSK (Frequency Shift Keying) of this carrier signal. Details on the Powerline modem can be found (e.g.) in the technical description of the SMA-NLM.

## Nominal charging throughput

The charging throughput is the cumulative total discharge current over time, measured in ampere hours (Ah). These meters are not automatically reset after charging. The nominal charging throughput is the charging throughput with regard to the nominal capacity of the batteries.

## Overload capability

The overload capability of an inverter describes its ability to supply short-term (seconds or minutes) excessive loads that can be significantly higher than the nominal capacity of battery inverters. The overload capability is important to allow startup of electrical machines which have a nominal power output close to the nominal power output of the stand-alone grid inverter, since these machines typically require six times the nominal current when starting.

## Parallel connection

Parallel connection of batteries (all positive poles together and all negative poles together) increases the capacity of the battery bank while keeping the voltage constant. Example: two 24 V/100 Ah batteries connected in parallel still have a voltage of 24 V, but have a capacity of  $100 \text{ Ah} + 100 \text{ Ah} = 200 \text{ Ah}$ .

## Photovoltaics

See PV

## Piggy-Back (board)

A printed circuit board which is plugged into another board to increase performance or expand capabilities. A piggy-back board can also replace an individual chip. In this case, the chip is removed and the board is plugged into the empty socket.

## PLC

Abbreviation for Power Line Communication: describes the process of data transfer over the grid supply cables. The PLC power module is used to amplify the signal and is connected in Multi-String and Sunny Mini Central inverters.

## PV

Photovoltaics (PV) is the conversion of solar irradiation into electrical energy using special semiconductors, so-called solar cells.

## PV generator

Technical device for the conversion of solar energy into electrical energy. This term encompasses all the electrically connected (in series and in parallel) solar modules in a PV system.

## PV module

See Solar module

## PV system

Describes a solar power system for generating electrical power. This includes the complete collection of components needed for the acquisition and utilization of solar energy. As well as the PV generator, this also includes the Sunny Boy or Sunny Mini Central inverter, for example, in the case of grid-connected systems.

## Self discharge

Capacitance loss of a battery cell while it is stored or not used. A higher ambient temperature has a strong influence on self discharge.

## Series connection

In this case the positive pole of each battery is connected to the negative pole of the next battery. There is only one circuit where current can flow. Series connection increases the voltage of the entire battery bank. If two 24 V batteries with a capacity of 100 Ah each are connected in series, the total voltage is  $24\text{ V} + 24\text{ V} = 48\text{ V}$ , while the total capacity remains at 100 Ah.

## Slave

A configuration setting which assigns a subordinate role in a cluster to a Sunny Island or Sunny Backup inverter. Thus, this device is relieved of control tasks and monitoring tasks, which must (or may) only be performed by one device in a cluster (-> master). Slave devices accept the configuration settings, present firmware, and start/stop commands from the master, and report these events, as well as warnings and error messages.

## SOC

State of Charge: the charge level of the batteries, see Charge level. If, for example, 25 Ah are taken from a 100-Ah battery, the charge level (SOC) is then 75 %.

## SOH

State of Health: describes the relationship between the present capacity and the battery's nominal value, given as a percentage.

## Solar cell

An electronic component which generates electrical energy when irradiated with sunlight. Since the voltage produced by a solar cell is very small (approx. 0.5 V), several solar cells are combined to form a solar module. The most common semiconductor material presently used for solar cells is silicon, which is manufactured in different forms (monocrystalline, polycrystalline, amorphous). In addition to vastly different mechanical variations, which are usually designed to increase the level of efficiency, completely new materials are currently being tested (cadmium telluride, cadmium indium sulphide, titanium dioxide and many others).

## Solar energy

"Sun energy", this means energy from sunlight or other solar radiation (heat and/or UV radiation).

## Solar module

Electrical connection of several solar cells encapsulated in a housing to protect the sensitive cells from mechanical stress and environmental influences.

## Stand-alone grid system

An energy generation system which is completely independent of any external power sources.

## String

Describes a group of solar modules electrically connected in series. A PV system usually consists of a number of strings, which avoids excessive yield losses caused by variations in shadowing on different modules.

## String inverter

An inverter concept which avoids the disadvantages of the central inverter concept. The PV generator is split into individual strings, each of which is connected to the external grid by means of its own string inverter. This greatly simplifies installation and reduces the yield losses which can be caused by manufacturing deviations or variations in shadowing on the solar modules.

## Sub-cluster

Cluster in a multicluster system which is subordinate to a main cluster, and thus does not lead the entire system.

## VRLA

Valve regulated lead acid battery: lead-acid battery with semi-solid electrolyte or closed lead acid battery. Examples of this type of battery are gel batteries and AGM batteries (Absorbent Glass Mat).





The information contained in this document is the property of **SMA Technologie AG**. Publishing its content, either partially or in full, requires the written permission of **SMA Technologie AG**. Any internal company copying of the document for the purposes of evaluating the product or its correct implementation is allowed and does not require permission.

## Exclusion of liability

The general terms and conditions of delivery of **SMA Technologie AG** shall apply.

The content of these documents is continually checked and amended, where necessary. However, discrepancies cannot be excluded. No guarantee is made for the completeness of these documents. The latest version is available on the Internet at [www.SMA.de](http://www.SMA.de) or from the usual sales channels.

Guarantee or liability claims for damages of any kind are excluded if they are caused by one or more of the following:

- Improper or inappropriate use of the product
- Operating the product in an unintended environment
- Operating the product whilst ignoring relevant, statutory safety regulations in the deployment location
- Ignoring safety warnings and instructions contained in all documents relevant to the product
- Operating the product under incorrect safety or protection conditions
- Altering the product or supplied software without authority
- The product malfunctions due to operating attached or neighboring devices beyond statutory limit values
- In case of unforeseen calamity or force majeure

## Software licensing

The use of supplied software produced by **SMA Technologie AG** is subject to the following conditions:

This software may be copied for internal company purposes and may be installed on any number of computers. Supplied source codes may be changed or adapted for internal company purposes on your own responsibility. Drivers may also be transferred to other operating systems. Source codes may only be published with the written permission of **SMA Technologie AG**. Sub-licensing of software is not permissible.

Limitation of liability: **SMA Technologie AG** rejects any liability for direct or indirect damages arising from the use of software developed by **SMA Technologie AG**. This also applies to the provision or non-provision of support activities.

Supplied software not developed by **SMA Technologie AG** is subject to the respective licensing and liability agreements of the manufacturer.

## Trademarks

All trademarks are recognized even if these are not marked separately. Missing designations do not mean that a product or brand is not a registered trademark.

**SMA Technologie AG**

Hannoversche Straße 1-5

34266 Niestetal

Germany

Tel. +49 561 9522-0

Fax +49 561 9522-100

[www.SMA.de](http://www.SMA.de)

E-mail: [info@SMA.de](mailto:info@SMA.de)

© 2004 – 2007 SMA Technologie AG. All rights reserved.



**Sales**  
**Solar Technology**

[www.SMA.de](http://www.SMA.de)

**SMA Technologie AG**  
**Hannoversche Strasse 1-5**  
**34266 Niestetal, Germany**  
**Tel.: +49 561 9522 4000**  
**Fax: +49 561 9522 4040**  
**E-mail: [sales@SMA.de](mailto:sales@SMA.de)**  
**Freecall: +800 SUNNYBOY**  
**Freecall: +800 78669269**



Innovation in Systems Technology  
for the Success of Photovoltaics

